

GAMES WORKSHOP™

PRESENT THEIR MONTHLY GAMES MAGAZINE

WHITE DWARF®



CITADEL
MINIATURES

135

£1.95

\$3.95

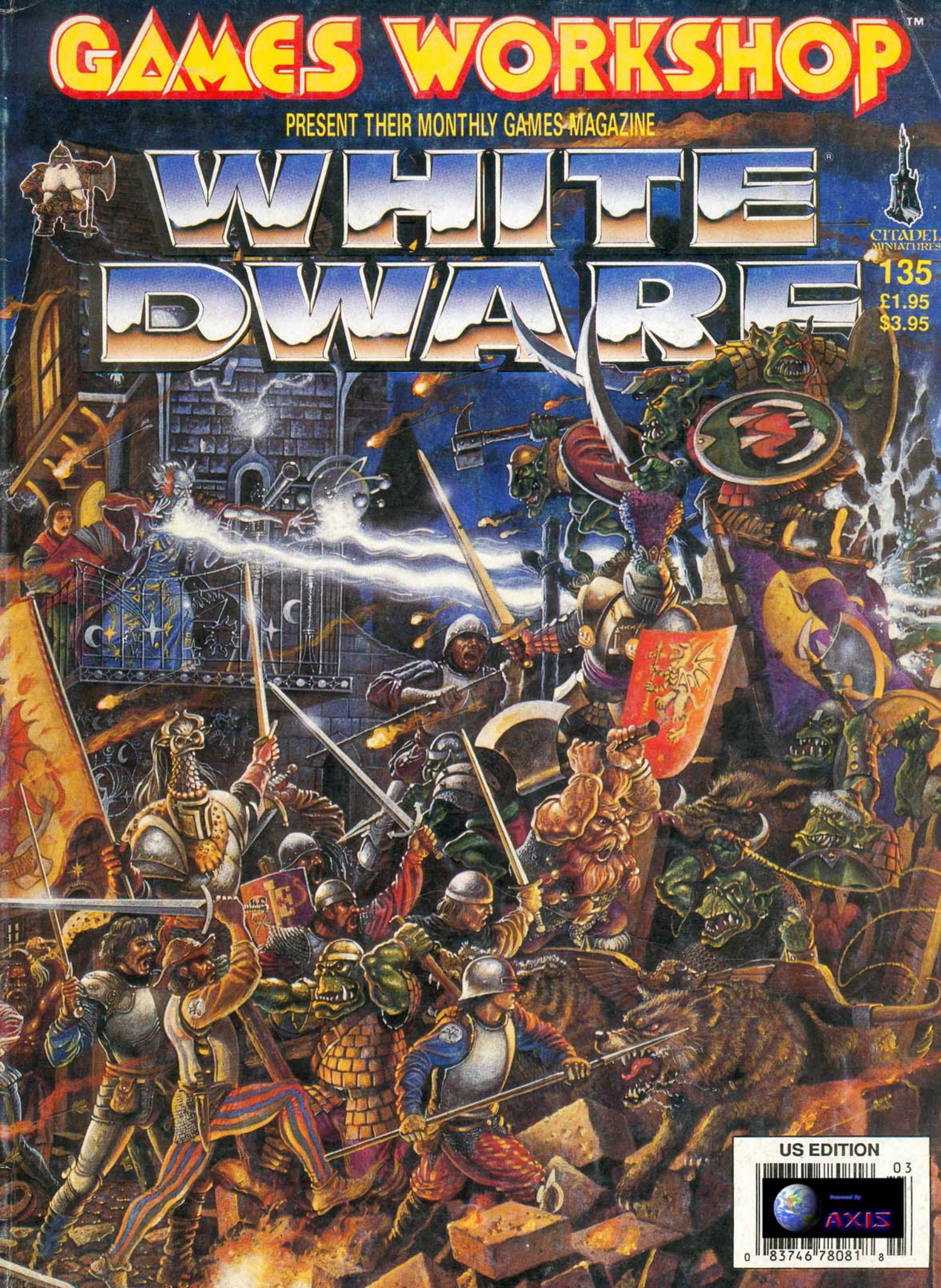

US EDITION

03



AXIS

0 83746 78081 8

'ERE WE GO

ORKS IN WARHAMMER 40,000

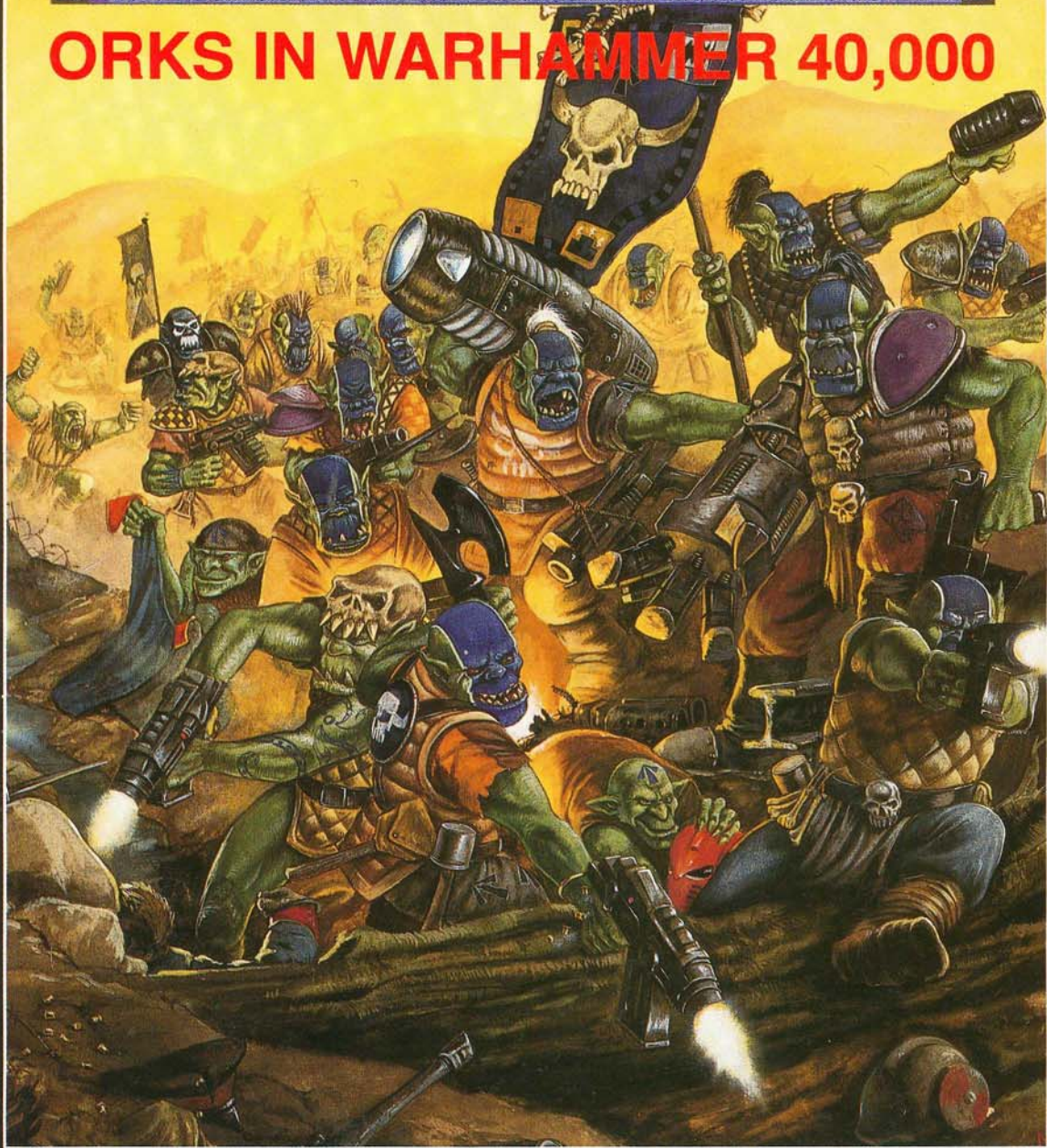

'Ere We Go! is the latest volume about Orks in Warhammer 40,000 and contains army lists for three Ork Clans: the Goffs, the Snake Bites and the Blood Axes.

The book also includes game rules that cover Painboyz, Bionik Bitz, Runtherdz, Weirdboyz, Madboyz, Mekboyz, Tinboyz, the Squig Katapult, the Hop-Splat Field Gun, the Shokk Attack Gun, Kustom Weapons, Kombi Weapons, and Data Sheets for Ork vehicles

Also included is the definitive description of how to paint your Ork army, admirably demonstrated with Waa-Ghazghkull's Goff Warband.

**GAMES
WORKSHOP**



**CITADEL™
MINIATURES**

Product Code: 0950
Ref. No: 00950₀
ISSN: 0265 - 8712

Editor: Simon Forrest
Published by Games Workshop Ltd

PRODUCED BY
THE GAMES WORKSHOP
DESIGN STUDIO

Printed by Artisan Press Ltd, Leicester, UK.
All correspondence except subscriptions and Mail Order should be addressed to: *White Dwarf, Games Workshop Design Studio, Enfield Chambers, 14-16 Low Pavement, Nottingham NG1 7DL.*

SUBSCRIPTIONS

Please send and make remittance to: *Games Workshop, Chewton Street, Hilltop, Eastwood, Notts NG16 3HY. Telephone (0773) 713213 or 760462.* White Dwarf is published monthly. Annual subscription rates are: UK - £15.00; Europe £36.00; other overseas surface - £36.00; other overseas airmail - £54.00. Please make all payments in Pounds Sterling.

US/CANADA - check or money order - \$35.00 for US residents (Maryland residents add 5% sales tax); \$45.00 - Canadian residents. Cheques made payable to GAMES WORKSHOP and sent to WHITE DWARF MAGAZINE SUBSCRIPTIONS, Games Workshop Inc., 3431 Benson Ave, Baltimore, Maryland 21227. For VISA and MASTERCARD subscriptions telephone (301) 644 5699.

When you want to inform us of a change of address or subscription renewal, or if you have a query, please write to the appropriate subscription address and make sure that you tell us your name and present address (and your old address if you are moving). When you subscribe, please tell us whether you are renewing an old subscription or starting a new one.

ADVERTISING

For details of advertising rates and copy dates, contact Steve How at Games Workshop Design Studio, Enfield Chambers, 14-16 Low Pavement, Nottingham, NG1 7DL.

The publishers of White Dwarf regret they cannot accept responsibility for financial transactions between readers and advertisers. White Dwarf reserves the right to amend or reject any material submitted for publication as an advertisement.

CONTRIBUTIONS

The Editor will be pleased to accept any previously unpublished articles for inclusion in White Dwarf. All submissions should be typed, double-spaced with 30mm margins, on one side of A4 paper only, and should be accompanied by an explanatory covering letter and a stamped self-addressed envelope large enough to return the submission. Hand-written submissions will not be considered. Please state clearly on the envelope which game the submission is for.

ARTWORK SUBMISSIONS

We are happy to look at samples of black and white artwork but, in order to deal efficiently with such material, we require that all artwork be submitted as photocopies together with a stamped self-addressed envelope in order for us to reply and return the artwork. Please address all artwork to the Art Editor at the Design Studio address.

For both articles and artwork, please allow at least 6-8 weeks for a reply.

RENEWABLE RESOURCES

White Dwarf is printed on paper from the Myllykoski Paper Mill, Finland. For every tree cut down, the mill plants two more. These are farmed trees grown specifically for this purpose and their use in no way diminishes the natural stock.

All Games Workshop's boxes, cards and counters are printed using 95% recycled paper.

All subject matter in White Dwarf is copyright Games Workshop Ltd.

All artwork in all Games Workshop products and the images contained therein have been produced either in-house or as work for hire. The exclusive copyright on the artwork and the images it depicts is the copyright of Games Workshop Ltd. Copyright © 1991 Games Workshop Ltd. All rights reserved.

Games Workshop and the *Games Workshop* logo, *Citadel Miniatures* and the *Citadel Miniatures* logo, *Warhammer 40,000*, *Epic*, *Adeptus Titanicus*, *Titans*, *3D Roleplay Hobby Game*, *Talisman*, *Space Marine*, *Space Hulk*, *Advanced Heroquest*, *Mighty Empires*, *Chivalry*, *Confrontation*, *Games Day* and *Golden Demon Awards* are trademarks of Games Workshop Ltd. *White Dwarf* and the *White Dwarf* figure, *Blood Bowl*, *Warhammer*, *Realm of Chaos* and *Dark Future* are registered trademarks owned by Games Workshop. *Marauder* is a trademark owned by Marauder Miniatures Ltd; *Flame* is a trademark owned by Flame Ltd; the *GW Books* logo is a trademark owned by GW Books Ltd - all used with permission.

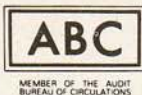

ISSUE 135 MARCH 1991

AUDITED AT
66,257 COPIES
PER MONTH

WHITE DWARF

CONTENTS

COVER: ALTDORF - <i>Fangom</i> Imperial Knights and Wizards defend Aldorf against a Goblin invasion	
GAMES WORKSHOP AND CITADEL MINIATURES NEWS Up-to-the-minute info on the latest from Games Workshop and Citadel Miniatures	2
GAMES WORKSHOP STORE NEWS The pick of next month's events at Games Workshop stores in the UK, US and Canada with a full list of store addresses, phone numbers and Games Club evenings	4
WAYNE ENGLAND'S DWARF LONGBEARDS Games Workshop artists Wayne England and Stephen Tappin are building a Dwarf army - we take a look at the fast, simple painting technique Wayne used on a unit of 20 Longbeards	8
MIGHTY EMPIRES - <i>Rick Priestley</i> New rules for working out battle results and employing agents based on Rick's own Mighty Empires campaign	10
MODELLING WORKSHOP: RUINED TEMPLE - <i>Dave Andrews & Phil Lewis</i> Simple instructions for making a ruined temple that can be used as terrain in games of <i>Warhammer Fantasy Battle</i> and <i>Warhammer 40,000</i>	14
FREEBOOTERZ - <i>Bryan Ansell, Nigel Stillman and Rick Priestley</i> Freebooterz are bands of outcast Orks who hire themselves out as mercenaries. Here's a sample of the forthcoming <i>Warhammer 40,000 Ork Freebooter army lists</i> with details of Bad Docs, Flash Gitz and Ork-Genestealer Hybrids	18
MODELLING GUIDE - <i>John Blanche</i> Converting miniatures to fill those awkward gaps in your armies is great fun. This guide to the art of miniature conversion takes a close look at several of our own units: Dale Hurst's <i>Tzeentch Warband</i> led by the Champion-Sorcerer Mutarchus, <i>Zodgog's Brood</i> of Ork-Genestealer Hybrids and <i>Kaptin Badrukk's Flash Gitz</i>	26
KUSTOM WEAPONS - <i>Bryan Ansell, Nigel Stillman and Rick Priestley</i> Ork Mekaniaks are masters of invention, able to build the most astounding, destructive and noisy weapons from cannibalised spare parts and battlefield loot	40
GAMES WORKSHOP SHEFFIELD GRAND RE-OPENING Special discounts for the Sheffield Re-Opening on 23rd March	47
WARHAMMER 40,000 VEHICLE POINTS VALUES - <i>Nigel Stillman</i> We've been using the new <i>Warhammer 40,000</i> vehicles rules for a while now and have decided to revise the vehicle points values	50
WARHAMMER 40,000 VEHICLE DATA RECORDS - <i>Rick Priestley</i> New rules and targeting diagrams for the <i>Imperial Jet Bike</i> and <i>Eldar Jet Cycle</i>	52
GENESTEALER INVASION - <i>Dean H Bass</i> Three <i>Space Hulk</i> missions which can be played as stand-alone games or as a campaign where the outcome of each mission affects your chances in the next	57
GAMES WORKSHOP OXFORD GRAND OPENING Oxford's Grand Opening is on 9th March - special discount vouchers for use on the day	59
MARIENBURG - <i>Graeme Davis</i> We take another visit to <i>Potion Square</i> in the busy city-port of <i>Marienburg</i> - part of a continuing series for <i>Warhammer Fantasy Roleplay</i>	64
BACK COVER: ORK FREEBOOTERZ - <i>Paul Bonner</i>	

ADVERTS

'Ere We Go.....	Inside Front	White Dwarf Subscriptions.....	60
Golden Demon Awards 91 Finals.....	3	Games Workshop Career Opportunities.....	73
Dark Future Novels - Comeback Tour.....	7	Games Workshop Mail Order.....	74
Warhammer Fantasy Novels - Storm Warriors...13		Citadel Miniatures Catalogue.....	75
Marauder Miniatures - Chaos Army.....	54	Flame Publications.....	Inside Back



Dave Andrews



Bryan Ansell



John Blanche



Phil Lewis



Rick Priestley



Nigel Stillman

GAMES™ WORKSHOP AND CITADEL™ NEWS

FREEBOOTERZ

Off to the printers any day now is *Freebooterz*, a book of Warhammer 40,000 Ork army lists.

The book contains the complete Ork *Freebooterz* army list, including details of mobz such as *Renegade Meks*, *Wildboy Outlaws*, *Bad Ork Bikeboyz*, *Weirdboy Warheadz* and *Ork Mutants* – elsewhere in this issue you'll find a taster of the *Freebooterz* list.

Also in the *Freebooterz* book are the Ork clan army lists for *Bad Moons*, *Death Skulls* and *Evil Sunz*.

The army lists for *Goffz*, *Snake-Bites* and *Blood-Axes* are in *Ere We Go* which should be available in the stores early in March. The *Freebooterz* book will follow later in the spring.

HEROQUEST COMPUTER GAME

MB Games' *Heroquest* is being turned into a computer game by Gremlin.

We don't have any details of the game yet, but it's due out around Easter. Watch this space for more info.

PRICE RISES

Regrettably we have to announce price rises for all our games and miniatures.

It's been three years since our last price rise and, in the meantime, inflation and the cost of lead have risen dramatically, increasing our costs.

To give you an idea of some of the new prices: *Advanced Space Crusade* and *Advanced Heroquest* are going to be £24.99; other large boxed games, such as *Space Marine* and *Blood Bowl* will cost £22.99; *Warhammer 40,000* will be £11.99; and a typical blister pack will now be £3.99 for 4 miniatures.

These new prices will take effect from the 18th of March.

IAN WATSON

Ian Watson, author of the Warhammer 40,000 novel *Inquisitor*, is currently working on a *Space Marine* novel.

Ian's been busy for a few months doing some work on a science fiction movie with Stanley Kubrick, director of *2001: A Space Odyssey* and *Full Metal Jacket*.

Ian's already written a 15,000 word *Space Marine* short story and we've asked him to develop it to full novel length.

D-ROK

D-ROK have completed final mixing on *Oblivion*, the first album to be released on the Warhammer label.

We've now heard the finished album at the Studio and we're very excited about it. As well as the album, there will be special 7" and 12" mixes of the first single, *Get Outta My Way*.



GAMES WORKSHOP VANCOUVER

We're about to open our second Canadian Games Workshop store, this time in Vancouver – in fact, by the time you read this, it'll probably already be open.

At the time of writing, we don't have a firm address for the shop, but we can tell you that it will be in the *Gas Town* area.

For more details, ring our Toronto store on 416 595 1159.

CANADIAN MAIL ORDER

Games Workshop Toronto is now running a Mail Order service and they'll be able to supply you with any Games Workshop games or Citadel Miniatures.

You can telephone the store on 416 595 1159 to place Mastercard or Visa credit card orders Monday to Saturday, 11am to 8pm (EST).

Please note that the store can only accept credit card phone orders. If you want to write in, send your order to our US Mail Order Service – see the Mail Order page at the back of the magazine for details.



Heroquest Expansion: the Citadel Miniatures designers have just finished some new models for an expansion to MB Games' *Heroquest*. We haven't got final details of what's appearing in the set, but we thought you'd like to see some of the new models: a *Man-at-Arms*, *Wizard*, *Chaos Sorcerer* and *Orc Sorcerer*.

GOLDEN DEMON AWARDS GRAND FINALS 91

THE 4TH INTERNATIONAL CITADEL MINIATURES PAINTING CHAMPIONSHIPS
ASSEMBLY ROOMS DERBY, 10am - 6pm SAT 25TH MAY

TICKETS AVAILABLE NOW – £3.50 ON THE DOOR OR £2.50 IN ADVANCE FROM GAMES WORKSHOP STORES AND GAMES WORKSHOP MAIL ORDER (0773 760462 or 0773 713213)

- Thousands of superbly-painted Citadel Miniatures
 - Magnificent Games Workshop art displays
- All the latest releases on sale from Games Workshop and Citadel Miniatures
 - Seminars by Games Workshop games designers
 - Demonstration and participation games

SPECIAL COACHES TO DERBY ARE BEING ARRANGED BY ALL GAMES WORKSHOP STORES – SEE YOUR LOCAL STORE MANAGER FOR MORE DETAILS

GAMES WORKSHOP™

UK STORE NEWS EVENTS FOR MARCH

There are always exciting events going on at your local Games Workshop store, including gaming demonstrations, tournaments, bring'n'battles, painting workshops and auctions. We've only got room to give details of a few of the special events – to avoid missing out, drop into your local Games Workshop store and ask what's planned for the following weeks. Keep in touch because there are new events being announced all the time. The stores are also the centre for the Gaming Leagues in your area. If you haven't already joined the Leagues, it's not too late – ask for a rulebook and entry form at your store. And if you want a game but can't find an opponent, talk to your local store manager and he'll see if he can help.

HAMMERSMITH

Sat 9th – All-Day Mighty Empires Campaign: Test your skill and see how far your realm can spread against opposing empires. If you'd like to take part, just come along on the day.

Sat 23rd – Advanced Space Crusade Participation: Can your Imperial forces take control of the Tyranid ship? Just bring in a painted squad of Space Marines and battle the deadliest foe of the Imperium.

OXFORD

Sat 2nd – Warhammer Fantasy Bring'n'Battle: The call to arms goes out! Bring along 300 points of painted Warhammer Fantasy Battle units and fight to victory.

Sat 23rd – Warhammer 40,000 Bring'n'Battle: If you'd like to play, bring in 500 points of painted Warhammer 40,000 miniatures and join in a great battle on the edge of the Imperium.

LEEDS

Mighty Empires Campaign: This will be played on our new 3D Mighty Empires map. Come in and sign up to join the quest for the crown of the king. See Tim for details.

Warhammer Fantasy Battle: The store's Nurgle Army is eagerly seeking new opponents. If you have a Warhammer Fantasy Battle army of any size, whether you've played before or not, come in and arrange a battle.

GLASGOW

Sat 2nd – Space Marine Bring'n'Battle: Loyal Imperial Guard are defending a bridge against assaults by Traitor Space Marines. Bring along 1000 points of Epic Imperial troops to reinforce the defence. Register your force at the store before the 2nd.

Thurs 7th – Space Hulk: A mini-campaign is being held throughout March at our Gaming Club. Bring along two squads of painted Imperial Guard and attempt to escape from the Genestealer-infested hive city of Archeron.

CROYDON

Sat 2nd – Warhammer Fantasy Bring'n'Battle: In a living maze of collapsed buildings and strange ruins, danger lurks around every corner. To play, bring along a 2000 point League force and ask for Hans.

Sat 16th – Space Marine Participation Game: The Imperium battle against Orks for the control of the mineral rich lava planet known as Beukig. To join in this mass battle, bring along your Epic Imperial or Ork army. Contact Hans for further details.

SHEFFIELD

Sat 9th – Ork and Eldar Bring'n'Battle: Bring along 500 points of painted miniatures (no psykers or Avatars) and join the Eldar Exodites in their conquest of a new planet. Or help the Ork raiding party, also with an eye on the planet in this Warhammer 40,000 battle.

Sat 23rd – Kussar's Last Stand: Vladimir Kussar has been trapped in his winter fortress by the great Orc leader Grabba Red Eye. Unable to get a message to the Tsar, he now has to stand and fight. Anyone wishing to join either of these forces in this Warhammer Fantasy Battle should contact Rick or Markham for further details.

YORK

Sat 23rd – Advanced Space Crusade Bring'n' Battle: Bring along a painted force of up to 300 points and do battle with the assembled aliens under the control of Tim Kirk. The game begins at 10am.

Sat 30th – Painting Demonstration: Back by popular demand, Ian Spence will be demonstrating his painting techniques and offering advice. If you have any questions or you just want to see a master at work, come along and watch. Demonstration starts at 10am.

EDINBURGH

Thurs 14th – Advanced Space Crusade and Space Hulk Painting Clinic: If you're having trouble painting those miniatures that you got for Christmas, bring them down to the store and get some expert help from us.

Thurs 28th and Sat 30th – Raid on Altara V: All communication with the Imperial settlement has ceased. Bring along 2000 points of troops, vehicles and Titans/Gargants for this epic Space Marine battle and find out what has happened. League points and bonuses for all players on the day.

Don't forget that the Edinburgh shop is open for League games every Sunday from 11am-5pm. It is also opening every Wednesday until 9pm for Warhammer Fantasy Battle and Warhammer 40,000 games.

PRESTON

Sat 1st – Waaargh! Warhammer 40,000 bash with da Orks defendin' their 'ome from 'ordes of Tyranid mind slaves. Bring along 1000 points of mind slaves and a Tyranid Warrior to help destroy the Orks of Gobrott's World as they defend their planet from Hive Fleet Kraken.

Sat 23rd – Super Slaughter Bowl 23: A day-long knockout Blood Bowl tournament where teams battle to the final and the honour of carrying off the Super Slaughter Bowl trophy. Is your team the one with the right mixture of guts, skill and mindless brutality to win?

NOTTINGHAM

Sat 3rd – Grand Auction: Bring along any games or miniatures you wish to sell. The auction will run from 12pm-5pm. Please make sure that you mark clearly each separate item with your name and address. We can promise some great bargains so come along.

Sat 16th – Warhammer Fantasy Battle demonstration game between Games Workshop artists Adrian Smith and Stephen Tappin. Adrian's hordes of Orks and Gobbos intend to storm the mountain pass held by Steve's doughty band of Dwarves. Both sides must be careful not to wake the sleeping Dragons which roost in the peaks.

LIVERPOOL

Sat 2nd – Painting Clinics: From 10am-12am Neil will be showing you how to paint Space Marine Scouts and Tyranids. From 1pm-4pm painting techniques for Epic scale and Mighty Empires will be demonstrated by Will.

Sat 9th – Chaos Warband Participation: Can your followers of Chaos outwit, outrun and outfight the Empire's border patrols? Starts 11am. Register your painted Warhammer Fantasy Battle Chaos Warband at the shop before the event.

READING

Store refit: We've just finished a major refit of Games Workshop Reading (Unit 3, Cheapside) – now the store's bigger and better than before. In fact, Games Workshop Reading has almost doubled its size, so there's plenty of room for fighting battles in the store. Contact Richard to reserve a table during the day or for the Wednesday and Thursday evening Games Clubs (tel: 0734 598693).

DERBY

Throughout March – Survival on Morlock VI: Space Marine Terminators fighting against overwhelming hordes of Genestealers have sent a signal for help. Although the distress call is answered the help is not quite what they expected... Sign up now for this Space Hulk campaign that will be running all through March.

SOUTHAMPTON

Every Thursday we'll be running a special painting demonstration to show you how to paint your Citadel Miniatures quickly but neatly. So just bring in a 400 point Warhammer Fantasy Battle force with no more than 100 points of missile troops.

Sat 30th – Warhammer Fantasy Battle Bring 'n' Battle: As a culmination of all your hard work we'll be running a participation game for your newly-painted armies. To take part, contact Rees or Stu at the shop.

BRISTOL

Sat 2nd – Mighty Empires: The start of Bristol's massive Mighty Empires/Warhammer Fantasy Battle campaign. Call in at the shop for further details.

Sat 23rd – Modelling Demonstration: Come along and learn how to build various pieces of scenery for your Warhammer 40,000 universe.

DUDLEY

Sat 9th – Advanced Space Crusade Mission Control: If you've already joined our Advanced Space Crusade League you'll have earned yourself a few honour points or decorations. If you haven't, then now's your chance to enroll for the greatest challenge to the Imperium. Contact Pete for more details.

LUTON

Sat 16th – Space Hulk Knockout: Our very popular one-day knockout tournaments continue this month with Space Hulk. Bring along a squad of painted Space Marine Terminators and battle their old enemies the Genestealers.

Sat 23rd – Design An Army Day: If you're having trouble with any aspect of army design, this is the day to come to the store. We'll have all the lists from Warhammer 40,000, Warhammer Fantasy Battle and Space Marine, as well as sound advice from Lance, Mark and John.

HARROW

Sat 30th – Blood Bowl Challenge: The Kum'n'Get Us Green Machine challenge any Blood Bowl team to score a single touchdown in a specified amount of time against Roger Barnett's Orc team.

MANCHESTER

Sat 9th – Painting Clinic: A complete painting session concentrating on Humans, Orks and Chaos faces. Whether you're painting to Golden Demon standard or painting whole armies, come along to learn some tricks to bring your miniatures to life.

Sat 23rd March – Painting Clinic: This week we'll be concentrating on armour and shields. Feel free to bring along your miniatures for discussion.

UK RETAIL STORES

WHERE TO FIND YOUR LOCAL GAMES WORKSHOP STORE AT A GLANCE

SCOTLAND

EDINBURGH
136 HIGH ST,
EDINBURGH, EH1 1QS
CLUB NIGHT: THURSDAY
CONTACT: MARC
TEL: 031 220 6540

GLASGOW
66 QUEEN ST,
GLASGOW, G1 3DS
CLUB NIGHT: THURSDAY
CONTACT: ALISDAIR
TEL: 041 226 3762

THE NORTH

LEEDS
12-16 CENTRAL RD,
LEEDS, LS1 6DE
CLUB NIGHT: WEDNESDAY
CONTACT: TIM
TEL: 0532 420834

SHEFFIELD
16 FITZWILLIAM GATE,
SHEFFIELD
CLUB NIGHT: THURSDAY
AND SUNDAY
CONTACT: RICK
TEL: 0742 750114

NEWCASTLE
63 CLAYTON ST,
NEWCASTLE-UPON-TYNE
CLUB NIGHT: THURSDAY
CONTACT: IAN
TEL: 091 232 2418

HULL
30 PARAGON STREET,
HULL
CLUB NIGHT: EVERY NIGHT
CONTACT: DAN
TEL: 0482 599576

YORK
26 GOODRAMGATE,
YORK, YO1 2LG
CLUB NIGHT: FRIDAY
CONTACT: EVAN
TEL: 0904 653675

PRESTON
15 MILLER ARCADE,
PRESTON, PR1 2QA
CLUB NIGHT: THURSDAY
CONTACT: SPENCER
TEL: 0772 821865

LIVERPOOL
23 BOLD ST,
LIVERPOOL, L1 4DJ
CLUB NIGHT: THURSDAY
CONTACT: STEVE
TEL: 061 708 6067

MANCHESTER
UNIT 1, 3 BROWN ST,
MANCHESTER, M4 3AB
CLUB NIGHT: THURSDAY
CONTACT: KARL
TEL: 061 832 6863

THE SOUTH

TORQUAY
12 MARKET ST,
TORQUAY, TQ 1AQ
CLUB NIGHT: TUESDAY
AND THURSDAY
CONTACT: ROB
TEL: 0803 201036

LUTON
12 PARK ST,
LUTON, LU1 3EP
CLUB NIGHT:
MONDAY TO FRIDAY
CONTACT: LANCE
TEL: 0582 417474

BRIGHTON
7 NILE PAVILIONS, NILE ST,
BRIGHTON, BN1 1HW,
CLUB NIGHT: FRIDAY
CONTACT: CHRIS
TEL: 0273 203333

SOUTHAMPTON
23 EAST ST,
SOUTHAMPTON, SO1 1HG
CLUB NIGHT: THURSDAY
CONTACT: CHRIS
TEL: 0703 331962

BRISTOL
13 BROAD WEIR, BRISTOL
CLUB NIGHT: THURSDAY
CONTACT: SHANE
TEL: 0272 251533

MAIDSTONE
UNIT 6, 1-9 PUDDING LANE
MAIDSTONE
CLUB NIGHTS:
MONDAY TO FRIDAY
CONTACT: GUY
TEL: 0622 677435

READING
UNIT 3, CHEAPSIDE,
READING
CLUB NIGHT: WEDNESDAY
AND THURSDAY
TEL: 0734 598693

OXFORD
1A BUSH HOUSE,
NEW INN HALL STREET,
OXFORD
CLUB NIGHT:
MONDAY TO FRIDAY
CONTACT: STEVE
TEL: 0865 242182



MIDLANDS

NOTTINGHAM
34A FRIAR LANE,
NOTTINGHAM, NG1 3DU
CLUB NIGHT: THURSDAY
CONTACT: CHRIS
TEL: 0602 480651

BIRMINGHAM
519 BRIDGELINK,
BULL RING CENTRE,
BIRMINGHAM
CONTACT: TED
TEL: 021 632 4804

DERBY
42 SADLER GATE
DERBY, DE1 3NL
CLUB NIGHT: THURSDAY
CONTACT: DOMINIC
TEL: 0332 371657

DUDLEY
KIOSK U, UPPER LEVEL,
MERRY HILL CENTRE,
BRIERLEY HILL, DUDLEY
CLUB NIGHTS:
MONDAY TO FRIDAY
CONTACT: SIMON
TEL: 0384 481818

LONDON

CENTRAL LONDON
UNIT F10, THE PLAZA,
116-128 OXFORD ST,
LONDON, W1R 1PA
CLUB NIGHTS: MON - FRI
CONTACT: PHIL
TEL: 071 436 0639

HAMMERSMITH
1 DALLING RD,
HAMMERSMITH,
LONDON, W6 0JD
CLUB NIGHT: THURSDAY
CONTACT: JOE
TEL: 081 741 3445

HARROW
296 STATION RD,
HARROW,
MIDDLESEX, HA1 2DX
CLUB NIGHT: MONDAY
CONTACT: DAVE
TEL: 081 861 2350

BECKENHAM
292-294 HIGH ST,
BECKENHAM,
KENT, BR3 1DY
CLUB NIGHT: THURSDAY
CONTACT: GARY
TEL: 081 658 8102

CROYDON
UNIT 35
DRUMMOND CENTRE,
KEELEY ROAD, CROYDON
CLUB NIGHT: EVERY NIGHT
CONTACT: PAUL
TEL: 081 680 4600

USA & CANADA EVENTS FOR APRIL

Over the next few weeks, Games Workshop stores are hosting the American Golden Demon Awards. Each Games Workshop store will continue to run its own gaming events and there will be special emphasis on painting and modelling clinics.

Judging will be at each store on Saturday April 20th. There will be plenty of exciting gaming and modelling events and the winners will be announced at the end of the day. Each winner will receive a Golden Demon badge and certificate.

HOW TO ENTER

Pick up an entry form from your local Games Workshop store. You'll find full details of the seven categories in last month's issue of White Dwarf – you can only enter once into each category.

Entries must be at the store by the following dates:

- March 30th – Single Miniature and Mounted Miniature
- April 6th – Monster, Command Group and Vehicle
- April 13th – Epic Battleforce and Vignette

REGIONAL FINALS

Winning entries from each Games Workshop store qualify to enter the Regional Finals on Saturday May 25th. The Regional Finals will be held in three locations:

- East Coast – Laurel, Maryland
- West Coast – Santa Monica, California
- Canada – Toronto, Ontario

Regional winners will receive Golden Demon trophies along with the admiration of their fellow gamers.

GAMES WORKSHOP STORES

CALIFORNIA
313 SANTA MONICA BOULEVARD
SANTA MONICA, CA 90404
CLUB NIGHT: MONDAY TO FRIDAY
CONTACT: DAVID
TEL: (213) 395 6711

FAIRFAX
FAIR CITY MALL
9600G MAIN STREET
FAIRFAX, VA 22031
CLUB NIGHT: MONDAY TO FRIDAY
CONTACT: OWEN
TEL: (703) 503 9284

COLLEGE PARK
UNIVERSITY OF MARYLAND
LEHIGH ROAD
COLLEGE PARK, MD 20740
CLUB NIGHT: MONDAY TO FRIDAY
CONTACT: SEAN
TEL: (301) 864 5668

PHILADELPHIA
424 SOUTH STREET
PHILADELPHIA, PA 19147
CLUB NIGHT: MONDAY TO FRIDAY
CONTACT: JEREMY
TEL: (215) 829 0554

LAUREL
LAUREL CENTER MALL
14858 BALTIMORE-WASHINGTON BLVD
LAUREL, MD 20707
CLUB NIGHT: MONDAY TO FRIDAY
CONTACT: FRANK
TEL: (301) 490 8853

TORONTO
331 QUEEN STREET WEST
TORONTO, ONTARIO M5V 2A4
CLUB NIGHT: EVERY NIGHT
CONTACT: MIKE
TEL: (416) 595-1159

INDEPENDENT STORES

The following independent stores are participating in the Golden Demon Awards 91. Competitions will be held in these stores on Saturday April 20th and the winners will qualify to enter the Regional Finals on May 25th. Call your nearest store for more information.

US STORES

ALPHA OMEGA GAMES
15965 PIUMA AVENUE
CERRITOS, CALIFORNIA
(213) 809 6849

ARMADILLO GAMES
2230 BROADWAY
SCHENECTADY, NEW YORK
(518) 377 6134

To coincide with the Golden Demon Awards, Armadillo Games celebrates its third anniversary on April 20th. The first 20 people through the door will receive free giveaways and there will be gaming events throughout the day.

ATOMIC COMICS
59 WEST MERCURY BOULEVARD
HAMPTON, VIRGINIA
(804) 723 5003

COMIC STORE WEST
915 LOCKS ROAD
YORK, PENNSYLVANIA
(717) 845 9198

DRAGON'S LAIR
5660 PACIFIC COAST HIGHWAY
LONG BEACH, CALIFORNIA
(213) 494 8366

GAME ROOM
201 WOODBRIDGE CENTER
WOODBRIDGE, NEW JERSEY
(201) 636 1111

GAMERS PARADISE
445 EAST PALATINE ROAD
ARLINGTON HEIGHTS, ILLINOIS
(708) 577 7586

GAMERS PARADISE
NORTH PARK MALL
VILLA PARK, ILLINOIS
(708) 279 1212

GAMERS PARADISE
142 SOUTH WAUKEGAN
DEERFIELD, ILLINOIS
(708) 498 0170

GAMERS PARADISE
CHICAGO RIDGE MALL
CHICAGO RIDGE, ILLINOIS
(708) 499 1121

GAMERS PARADISE
1435 ORLAND PARK PLACE
ORLAND PARK, ILLINOIS
(708) 460 8477

GAMERS PARADISE
2828 NORTH CLARK STREET
CHICAGO, ILLINOIS
(312) 549 1833

GAMERS PARADISE
4136A NORTH HARLEMAUE
NORRIDGE, ILLINOIS
(708) 456 1422

GAMETOWN
3954 HARNEY STREET
SAN DIEGO, CALIFORNIA
(619) 291 1666

LAST GRENADIER
335 NORTH SAN FERNANDO BOULEVARD
BURBANK, CALIFORNIA
(818) 848 9144

LAST GRENADIER
8823 RESEDA BOULEVARD
NORTHRIDGE, CALIFORNIA
(818) 886 3639

QUARTERSTAFF GAMES
152 CHURCH STREET
SOUTH BURLINGTON, VERMONT
(802) 863 3666

CANADIAN STORES

BUSHMAN GAMES
257 QUEEN STREET SOUTH
STREETSVILLE, ONTARIO
(416) 858 7507

LE VALET D'COEUR
4532 ST DENIS
MONTREAL, QUEBEC
(514) 499 9970

SILVER SNAIL
391 BANK STREET
OTTAWA, ONTARIO
(613) 232 2609

SILVER SNAIL
211 KING STREET EAST
HAMILTON, ONTARIO
(416) 522 9366

TROLLSBANE
775 STRAND BOULEVARD
KINGSTON, ONTARIO
(613) 389 0641

Continuing the nightmare
conspiracy first introduced in
DEMON DOWNLOAD
and
KROKODIL TEARS

1998, and the King of Rock'n' Roll is still alive. After a twenty year hitch in the US army, Colonel Elvis Aron Presley is back in circulation, his musical career long behind him, carving out a legend as the toughest independent Sanctioned Op in the South.

Presley's new employer is Krokodil, and his latest commission is a lot trickier than it sounds.

Under two inches of rancid water at Cape Canaveral, the computer guidance systems are still operational and Nguyen Seth, evil avatar of the apocalypse, is struggling to gain control of a near-obsolete system of orbital weapons.

Can Presley prevent the world from being encircled by a fist of high-tech death wielded by a madman? He will have to face the Ku Klux Klan, swamp-dwelling mutants, voodoo worshippers and a world-class terrorist to find out.

**ALSO
AVAILABLE
THROUGH
W.H. SMITHS AND
OTHER LEADING
BOOKSHOPS**

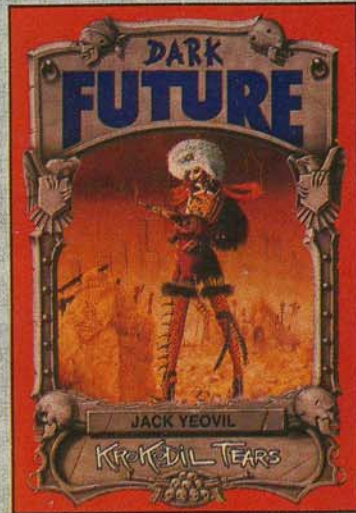
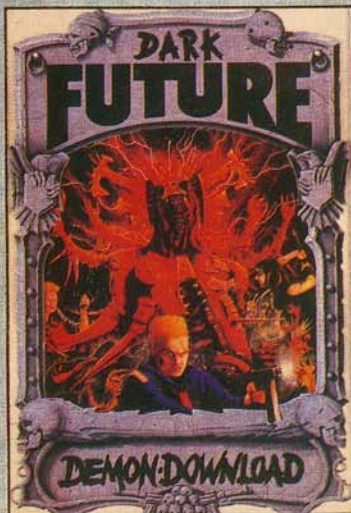
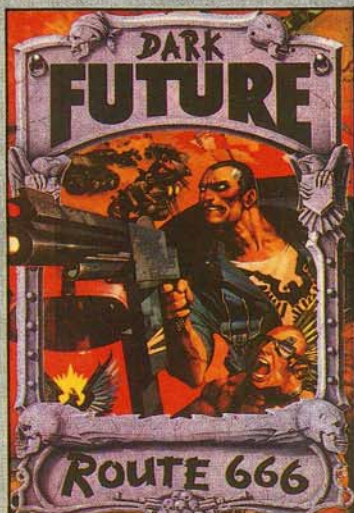
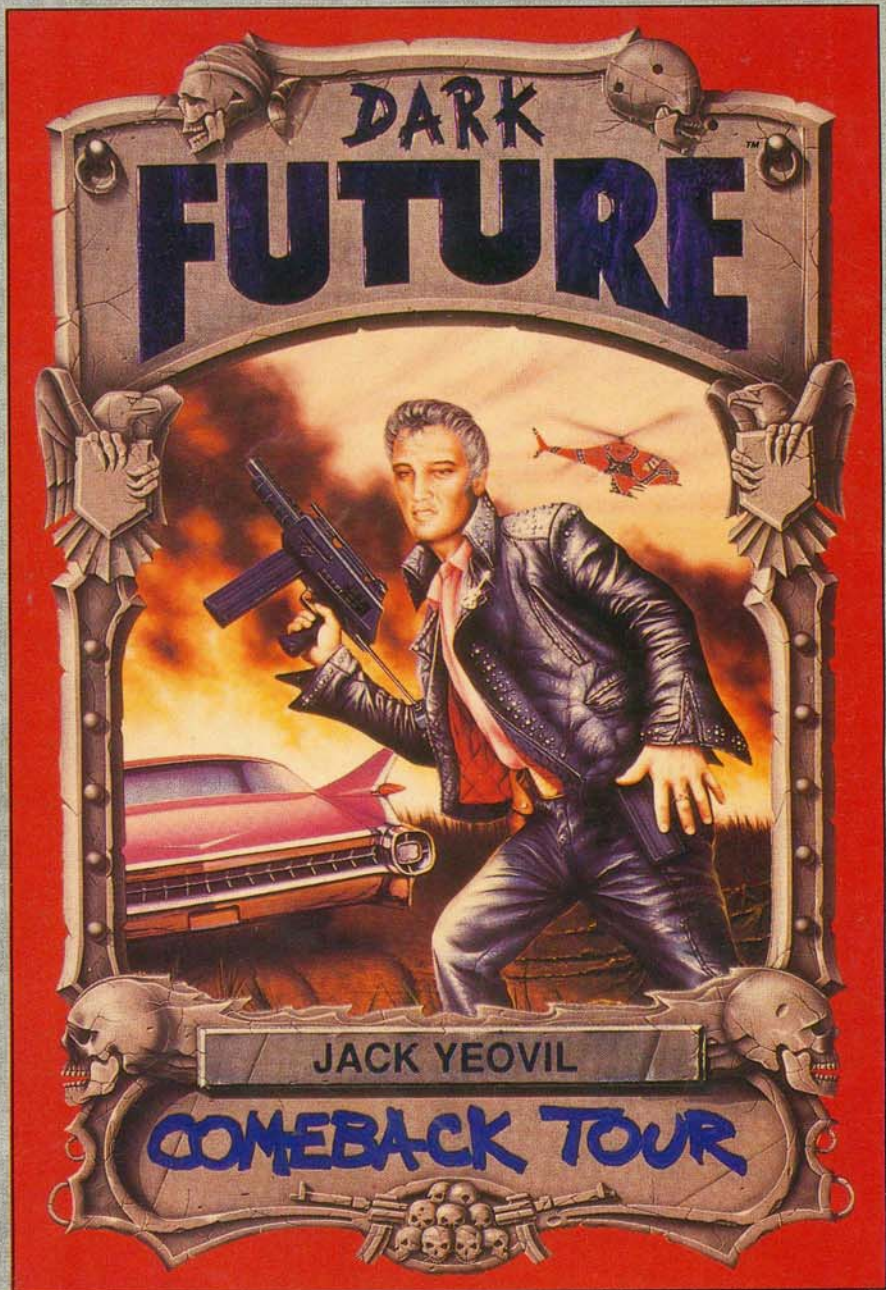

GW Books,
34 West Street,
Brighton, East Sussex,
BN1 2RE

Games Workshop Mail
Order, Chewton Street,
Hilltop, Eastwood,
Nottingham, NG16 3HY

Games Workshop Inc,
3431 Benson Avenue,
Baltimore, MD21227





WAYNE ENGLAND'S DWARF LONGBEARDS



Games Workshop artists Wayne England and Stephen Tappin are currently building a huge Imperial Dwarf army for Warhammer Fantasy Battle. When it's finished, it will be 5,000 points including allies. Wayne and Steve chose Dwarfs as there seemed to be lots of Orc, Chaos, Elf and Skaven armies around but no-one at the Studio was fighting with a Dwarf army. The large range of Dwarf Citadel Miniatures also gave them plenty of scope for painting, from bare-fleshed Troll Slayers to fully-armoured Hammerers.

Before they started, they decided on an overall feel for the whole army, focusing on blue as the household colour of the Dwarf king – all the units will have blue somewhere on them.

The first models Wayne's finished are a unit of Longbeards: elite Dwarfs in heavy armour. Wayne's chosen to give them a strong heraldic colour scheme using white and the household blue. Using blue for gloves, helmets and scabbards on some of the Dwarfs helps to reinforce the unifying theme.

Although Wayne's a brilliant artist, as you'll know from his work on our games and in White Dwarf, he didn't want to go

mad with his skills on these miniatures – after all, he's still got the rest of an army to paint!

He wanted a quick method of painting so he could get the unit onto the tabletop and into play as soon as possible. It'll take him quite a while to finish off the whole army, but he can start playing small battles once he's got two or three units ready.

So, rather than paint intricate symbols on tabards and shields, he chose a strong geometric pattern that will stand out clearly when the whole army's fielded. This is quick to paint and produces a neat, clean finish.

He decided to use simple solid colours as much as possible combined with quick drybrushing straight onto the undercoat where appropriate. This means that once he's undercoated the models, most areas need just one or two coats of paint. In fact, because the first coat defines all the main areas of colour, he can begin fighting battles with his Dwarfs even before he adds the second coat.

He started off by cleaning up the miniatures, sticking them to their bases and attaching their shields. He undercoated them with thinned-down Chaos Black and drybrushed the areas of mail and armour with Mithril Silver. Because the Dwarfs are heavily-armoured, he quickly produced good results.

Next Wayne used Skull White to neatly undercoat tunics, faces and so on. He made sure this coat opaquely covered the black to give a good base for the next stage. He left black showing around the edges of gloves, helmets etc so he didn't need to line these areas later.

The faces were painted with Bronzed Flesh and then given a thin wash of Brown Ink. The whites of the eyes and a small



Note the addition of the green and yellow band on the helmet – the same colours as on the pennant flying from the banner pole. Details like this give individuality to the models without destroying the unit theme.



This Longbeard with iron helmet and breastplate clearly shows how good Wayne's metal technique looks: simply Mithril Silver drybrushed over a Chaos Black undercoat. Note the white line painted on the dark mouth for teeth.



An occasional wounded model in a unit is very effective. This stain has been made by a small blood of red paint on a wet surface which allows the paint to spread and looks very realistic. It's best to underplay these effects – a whole unit drowned in gore looks terrible.

dot for the pupils were painted with a steady hand using a very fine brush – a thin black line was then added round the eyes to neaten them up.

The tunics and shields were painted in the unit's distinctive blue and white halved pattern. The blue areas were first painted with Moody Blue. Wayne then quickly blocked in the highlights, adding Skull White to Moody Blue for these. Once the paint was dry, the blue areas are completed with a wash of thinned Moody Blue. For the white areas, Wayne's simply added a thin wash of Brown Ink.

The Dwarfs' hair and beards hadn't been painted white so they were just given a drybrush of Elf Grey over the black.

Weapons and equipment were painted with browns, silver and gold as required. The black undercoat was left showing in the depressions, such as between the fingers, and at the edge of belts etc.

You'll notice that there's a mix of weapons carried by the Dwarfs but their unit profile lists them as armed with hand weapons. Wayne included some Dwarfs with double-handed weapons – and even one firing a pistol – to add variety to the Dwarfs' appearance. This is perfectly fine because the majority of the unit are armed with hand weapons such as swords, hammers and axes. On the tabletop, they all count as armed with hand weapons, whatever the model is actually carrying.



This model firing a pistol has his axe slung to his belt. Variant armaments and poses in a unit add realism, interest and movement.



Prince Kargrim, the unit's champion, is a member of the royal household, shown by his crowned helm.

You can see that Wayne's clever choice of a black undercoat has simplified the work he needs to do right the way through the painting, from the large areas of armour down to the small details. Although this is a fast and simple technique, the models look striking and make a great unit.

The bases were painted with Bestial Brown and Woodland Green. When this was dry, Wayne painted PVA glue onto the bases and sprinkled sand over them. Once the glue had set, he brushed off the excess sand and drybrushed the bases with a mix of Sunburst Yellow and Bilious Green.

Wayne cut the banner out of the metal foil of a tube of tomato puree. He deliberately kept the design simple, painting it with quarters of blue and white, the same colours used for the shields and tunics. The edge of the banner was frayed by making a lot small cuts very close together and this fringe was painted with Shining Gold.

Wayne fixed the banner to a piece of stiff, thick wire and then glued it into a hole he'd drilled in the top of the Dwarf's hand.

All in all, an impressive unit that will look great on the tabletop, painted with quick simple techniques.

We look forward to seeing more of this Dwarf army.



The dark lines left showing from the undercoat clearly define the different areas of colour and provide effective shadows.

PRINCE KARGRIM'S LONGBEARDS

These Longbeards are going to be a core unit in our Dwarf army, so we chose the maximum unit size. A musician and standard bearer are essential parts of the unit – the bonuses they give on the tabletop are well worth the points and the models give us the chance to add extra colour and character to the unit. Because we want the Longbeards to stand rock solid in combat, we made the standard a magical war banner. We've chosen to make Prince Kargrim a level 10 hero to get the unit's leadership up to the maximum 10.

19 LONGBEARDS – +2 DWARF SHOCK ELITE

M	WS	BS	S	T	W	I	A	Ld	Int	Cl	WP
3	5	3	3	4	1	3	1	9	7	9	9

Hand weapon, heavy armour and shield – unit includes musician and standard bearer with magic standard (war banner)

PRINCE KARGRIM – LEVEL 10 DWARF HERO

M	WS	BS	S	T	W	I	A	Ld	Int	Cl	WP
3	6	4	4	5	2	3	3	10+1	7	9	9

Hand weapon, heavy armour and shield

TOTAL UNIT VALUE – 407 POINTS

MIGHTY EMPIRES™

The ongoing Studio Mighty Empires game is really gathering pace with the coming year promising renewed conflict between the rival empires of Orks and High Elves in the north and Skaven and The Empire in the south. It's been quite a violent and bloody affair so far with two huge battles and countless smaller skirmishes. We've set up a large game by pooling four of our Mighty Empires sets and by buying some extra sets of plastic pieces on top.

Battles have so far proven decisive, with the Undead quickly disappearing from the face of the map following the destruction of their controlling Liche. The Priestley controlled Orks have not done quite as well as they might (must do something about that!). In particular Ork Warlord Badbog Elf-Krusha managed to get himself captured by the Elves after his entire army ran away. This humiliating event was made even worse by the Elven King's insistence on treating the prisoner with typically fastidious Elven hospitality and forcing him to wear silk undergarments (the shame was unbearable).

Maybe in a few months' time we'll write up our campaign for White Dwarf, or present you with an account of any interesting battles from it. Meanwhile we thought you might like to hear about some of the developments which we've found necessary. Many of these new and revised rules are designed to take into account our extra-large playing area. This, together with an inexhaustible supply of pieces means that our empires are quite large, and the armies they support are also fairly vast - so vast in fact that they strain the far reaches of the combat table! However, even a game with one set of pieces will benefit from these new and revised rules.

AGENTS

It is a good idea to limit the number of operatives available for espionage to the number of counters in the game - as we had several sets the world quickly became flooded with assassins whose activities were often far more costly in terms of life than the average battle! We found that no-one much bothered to try and stop assassins by means of agents because these were not felt to be sufficiently effective. In fact, most players find agents rather dull, preferring to take an aggressive stance by flooding their enemy's empire with assassins.

To off-set this we came up with a new chart for agents which makes them more interesting and effective. In particular we introduced the notion of agents moving from settlement to settlement to root out spies, saboteurs, assassins and enemy agents. We also came up with a double-agent rule that allows your agent to take over enemy operatives and use them against him. This double-agent rule is particularly appropriate

because it means players who want to use operatives must face the possibility that they might be turned against them. The result is that the Espionage Phase becomes less of a wholesale slaughter and more challenging into the bargain. It is suggested that you photocopy this article and keep the new rules inside your Mighty Empires rulebook, or alternatively you can cut out and paste the new agent rules over the existing ones.

The purpose of agents is to uncover plots against your empire and to infiltrate and root out networks of enemy operatives. Agents can be placed in your own settlements to protect them against enemy activity, and they can also be placed in enemy settlements in order to act against enemy operatives who might be there - notably other agents. The main difference between agents and other operatives is that agents can sometimes be used several times during the espionage phase. The player may use an agent only once during his turn of the espionage phase, but can return to the same piece in a subsequent turn if he wishes. Roll a D6 to determine the effect of an agent. Unless they are destroyed beforehand agent counters are removed from play once espionage is over.



AGENTS TABLE

D6 Result

- 1 The agent is uncovered by local authorities and quietly silenced. The agent is eliminated. Remove the counter.
- 2 The agent infiltrates a nest of enemy operatives and destroys one of them. You may look at all the operatives in the tile, choose and discard any one operative counter you wish and replace the rest face down. Your agent remains in place and may be used again in a subsequent turn.
- 3 The agent infiltrates and destroys an enemy espionage network. You may look at all the operatives in the tile, and remove all of one player's operative counters. Your agent remains in place and may be used again in a subsequent turn.
- 4 The agent is ruthlessly efficient and runs to ground all enemy operatives in the area. Remove all enemy operative counters from the tile. Your agent remains in place and may be used again in a subsequent turn.
- 5 Your agent smashes the local espionage ring and destroys all enemy agents in the tile. Remove all enemy operative counters from the tile. In the process your agent obtains vital information which enables him to follow up his operations in another settlement. The agent counter may be moved into any of your own settlements or to any settlement belonging to a player whose operatives the agent has destroyed this turn. The agent counter may be used again in a subsequent turn.
- 6 Your agent establishes a counter-espionage network of double agents, traitors, and other infiltrators. All the operative counters in the tile immediately become yours - the counters are removed and replaced with your own equivalents. Any operatives in the tile, including the original agent, may be placed immediately on any of your own settlements or any settlements belonging to players whose operatives have been taken over by the agent this turn.

An agent counter may be activated and moved back to any of his own side's settlements on the roll of a 5 or 6 even if there are no enemy operatives in the tile he is in. However, a roll of a 1 still leads to his being uncovered and destroyed - presumably by agitators, local militia, police or some other mysterious enemy.



RUSS NICHOLSON

BATTLE RESULT

We have found that especially large forces don't do very well out of the Battle Result Table because casualties are not relative to the number of troops fighting. Obviously a battle involving 1000 points on each side would not necessarily result in the same casualties as a battle involving 5000 points on each side. To represent this, the casualties caused on the Battle Result Table (p27 of the Mighty Empires rulebook) are multiplied by a further 1 for each full 1000 points in the opposing force at the start of the battle. For example, a force of less than 1000 points will inflict the casualties indicated on the table, a force of 1000-1999 will inflict twice as many casualties, a force of 2000-2999 will inflict three times as many, and so on. This new rule makes it harder for small forces to take on very large ones without suffering considerable losses - although with luck it is still possible to obtain a favourable result.

For example: A Dwarf force of 2500 points attacks an Elven force of 1500 points. The Combat Table indicates a +1 (favouring the Dwarfs), the Strategic Modifiers are equal, and the 2D6 dice roll is 8 - with the +1 this gives a result of 9: *Attacker Wins*. The Dwarfs have won the battle but lost D6x50 points. Rolling a 4 this equals 200 points multiplied by 2 because of the Elves' points value, which results in 400 points of casualties. The Elves have lost and so suffer 50+D6x50 points of casualties. Rolling a 2 this equals 150 points multiplied by 3 because of the Dwarfs' points value this results in 450 points of casualties.

RULES CLARIFICATIONS

P30. Add the following new rule under Starvation. This allows players to conduct sieges against independent settlements.

When conducting a siege against an independent fortress or city it is necessary to establish how much baggage the settlement has. At the start of the siege roll D6-2 to establish the amount of baggage held by the defenders - a score of less than 0 is always taken as 0.

P39. First paragraph. Delete from 'In order for a banner to retire...' to end of paragraph. Replace with the rule below. We found that with our large map it was too easy to retire using the old rules, and so decided to alter the rule governing the move to Winter Quarters.

In order for a banner to retire unhindered to Winter Quarters it must be able to trace a clear route through its own side's territory from its position at the end of the year to any unrazed tile in its own realm. There must be no blocking mountains or rivers. A route may not be traced through enemy, unknown, or razed territory. If a banner cannot trace a route to its realm via its own territory it must make a special Winter Retreat before it can move to Winter Quarters.

P39. Add the following new section to accommodate the inclusion of islands and overseas extensions to your empire. This allows banners cut off by ocean to return to Winter Quarters without making a Winter Retreat if the Empire contains sufficient sea transport.

SEA

Banners separated from their realm by sea may move to Winter Quarters without suffering the hardships of a Winter Retreat if there is sufficient sea transportation in the empire. For every ship counter in the empire, the player may retreat 1 banner across the sea. In order to return successfully to Winter Quarters the banner must still be able to trace a route from its position at the end of the year to a coast tile, and from the coast on the other side to its own realm. Banners returning to Winter Quarters from overseas do not have to trace their route via harbours - any coastal tiles in their empire will do.

Note that the process involved is not a literal one of a specific ship carrying a specific banner, rather the number of ship models is taken as standing for the general maritime capacity of the nation and its ability to move troops and supplies overseas. Banners unable to retreat in this way must make a Winter Retreat representing the haphazard requisitioning of boats and supplies from local sources.

P39 Winter Retreat - first paragraph, first sentence, delete 'or blocking enemy.' As it is no longer possible to retire over enemy territory without making a Winter Retreat roll it is obviously impossible to retire over territory occupied by an enemy banner.

P39. Winter Retreat - add the following new rule.

If a force has baggage left when making its Winter Retreat then the player may add +1 to the dice roll for each point of baggage carried. Any result of 6 or more counts as 6.

This makes Winter Retreats easier to cope with if you are properly prepared, and ensures that it is possible to invade over heavily razed territory with at least some possibility of making it back alive.

P47. Deployment. First paragraph, sentence beginning 'Banners cannot be deployed in barren tiles...' replace with:

Banners cannot be deployed in barren or razed tiles.

P47. Deployment. Replace last paragraph with the following.

If a player wishes to deploy a banner in a settlement that is entirely separated from his Realm by water (say on an offshore island or part of a peninsula that is cut off by an opposing empire) then he must also deploy one of his ships into a harbour in the same or an adjacent tile. If there is no harbour available it is still possible to deploy a banner into a settlement, but only if a newly constructed ship is also deployed in the same or an adjacent tile.

This rule represents the commitment to building new ships which is required to undertake maritime conquests in undeveloped territory.

P58. Orcs and Goblins. Fourth paragraph, replace sentence beginning 'If the force successfully scouts...' with the following new rule.

If the force successfully scouts an adjacent tile it must move into it regardless of what settlements or barren areas it contains. This represents the fact that the force has no time to put out proper outriders to investigate the local territory and so may stumble across enemy forces or hostile territory and be unable to avoid it.

This prevents Orc / Goblin players from exploiting the forced march rules to scout around them as they move, and explore new territory twice as fast as other races without making any real commitment to forced march.

P58. Skaven. Add to beginning of last paragraph.

In a Skaven Empire razed settlements are still considered to be part of the empire - so it is important to leave territory markers in place. Skaven banners may trace a route over these razed areas when they retire to Winter Quarters. If forced to retire over razed tiles which are not part of their empire Skaven banners are obliged to make a Winter Retreat just like any other race. This is because areas razed by them are in fact riddled with underground tunnels, food hoards, and other sub-surface supply sources which are unusable or undetectable by other forces.

ALSO AVAILABLE THROUGH W.H. SMITH AND OTHER LEADING BOOKSHOPS

WARHAMMER™



STORM WARRIORS BRIAN CRAIG

When a group of elves is marooned on the shore of his westerly realm, King Herla sends his bard to meet them, and the elves agree to attend the king's wedding. They bring three mysterious gifts: a bow, a cup and a seed from which will sprout an unearthly tree. But a fearsome wind blows from the northern Chaos Wastes and lends a terrible energy to the supernatural horsemen of the Storm Hunt.

In his third and final tale, the minstrel Orfeo recounts a dark and magical story from the island of Morien, one of the Isles of Albion. Orfeo's first two tales of horror and magic, *Zaragoz* and *Plague Daemon*, are also available from GW Books.

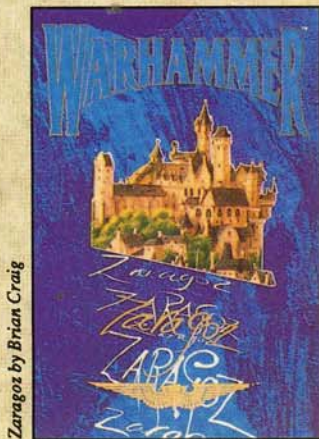
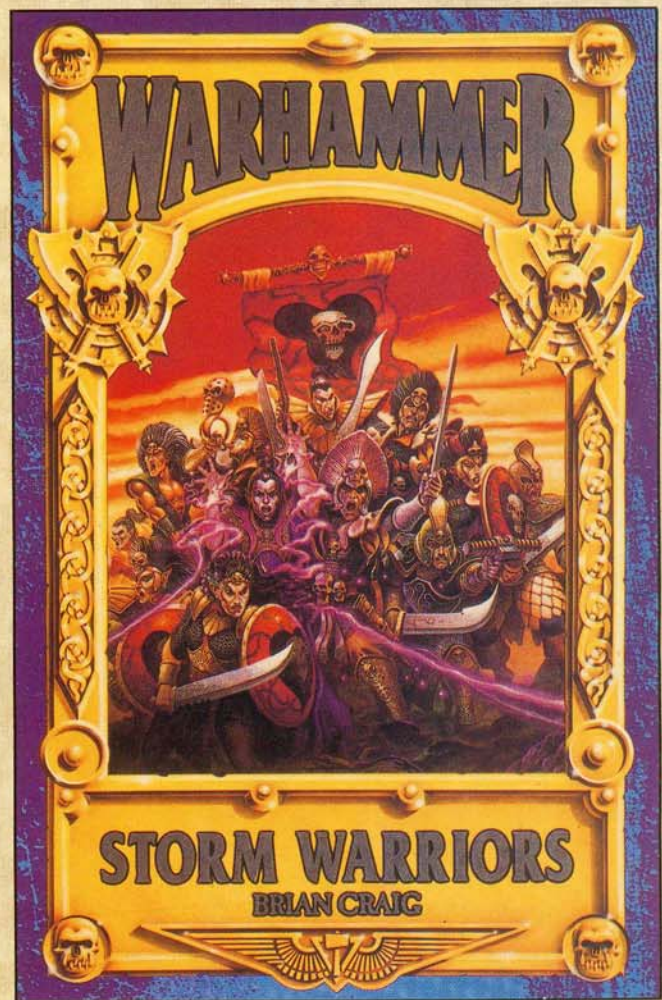

Zaragoz by Brian Craig



Plague Daemon by Brian Craig

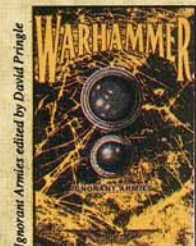

Ironant Armies edited by David Pringle

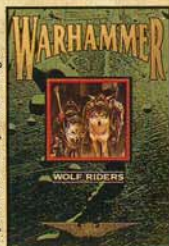

Wolf Riders edited by David Pringle



Red Thirst edited by David Pringle



Drachenfels by Jack Keovil



Konrad by David Ferring



Shadowbreed by David Ferring

GW Books,
34 West Street, Brighton,
East Sussex, BN1 2RE

Games Workshop Mail Order,
Chewton Street, Hilltop,
Eastwood, Nottingham,
NG16 3HY

Games Workshop Inc.,
3431 Bencan Avenue,
Baltimore, MD21227



MODELLING WORKSHOP

RUINED TEMPLE

BY DAVE ANDREWS AND PHIL LEWIS

This month we show you how to make a ruined temple. The temple can be used in either Warhammer Fantasy Battle or Warhammer 40,000 games – there are many planets throughout the Warhammer 40,000 universe containing the crumbling remnants of ancient civilisations. The temple is made with separate sections so you can expand or contract it to suit the size of your battle.

If you're an inexperienced modeller and you want some advice on any of the techniques described, or if you want to know where to get hold of the tools and materials you'll need, call in to your local Games Workshop store and they'll be more than happy to help you.

The ruined temple is made in several separate pieces: there are four corner sections, which can be long or short and may include archways, a number of broken pillars, and an altar as a centrepiece for the temple. When you use the ruined temple on the tabletop, you can choose some or all of these pieces as terrain. You could place just a single corner piece to represent

the temple's last remnants, or construct a large edifice with a colonnaded nave. Of course, you can make more than four corners and use the extra ones to represent wings off the main building, and you can choose any mix of short, long and arched corners. Using the basic instructions here, you can build as simple or as complex a ruined temple as you want.



SHORT CORNER SECTIONS

For the short corner sections, you'll need:

5mm Foam Card
1.5mm Balsa Wood
Scenic Scatter Material
PVA Glue

Mounting Board
Coral Sand
All-Purpose Glue

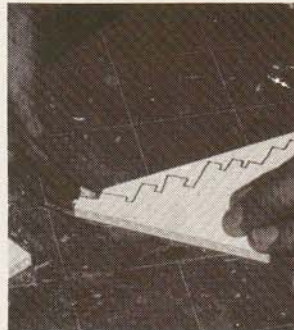
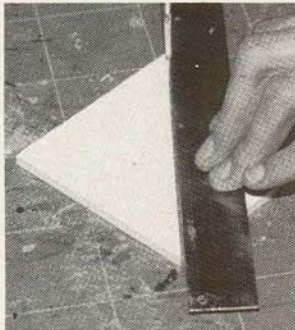

Take your foam card and cut out a square about 100mm x 100mm. Cut this diagonally so that you end up with two equal triangles. Draw a ragged line (similar to the one in the photo above) down the longest edge of each triangle and cut it away with your modelling knife. This gives you the initial stage of the broken brickwork effect you're aiming for.

Next, carefully peel back small areas of the card from the foam and tear these away exposing the foam underneath. With your fingernails or the tip of your modelling knife pick away the exposed foam. This will give you a ragged finish suitable for a broken-down wall.

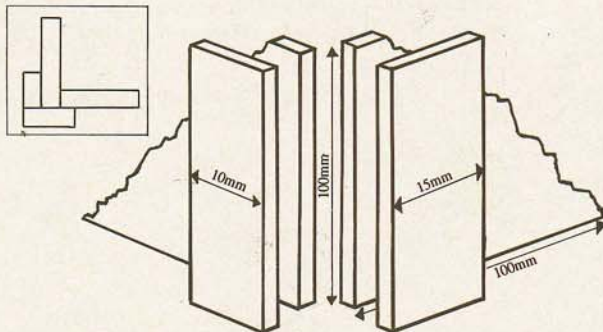

Referring to the exploded diagram above, you can now assemble the two triangular halves and fix them to a base of mounting card. Cut two strips of foam card to the same height as the top corner of the wall, making one about 15mm in width and the other about 10mm. Assemble the pieces as shown, making sure that you rough the top of each strip the same as before. Allow the glue to dry thoroughly before moving on to the next step.

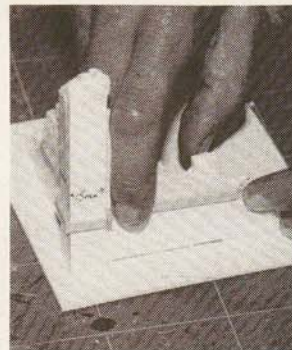

To add a decorative ledge to the inside and outside of the temple wall, cut several 5mm wide strips from a sheet of 1.5mm thick balsa wood. Attach them at ground level and at a convenient height just below half way up the wall with all-purpose glue.

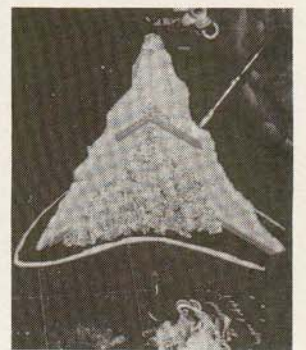

Once the glue's set, wash the walls with Tetrion filler and leave to dry. If, like us, you want to include further detail, you can add sections of rubble by using chopped up pieces of foam card offcuts glued into place with all-purpose glue. Then liberally brush PVA glue over the area and sprinkle on coral sand for a fine rubble texture. Shake off any excess sand after the glue has set.

If you want to make some separate smaller patches of rubble, you can use the same techniques. Cut out an irregular piece of mounting card, then spread foam card offcuts and coral sand as before. You can place these rubble patches around your temple to give the effect of broken ground.

LONG CORNER SECTIONS

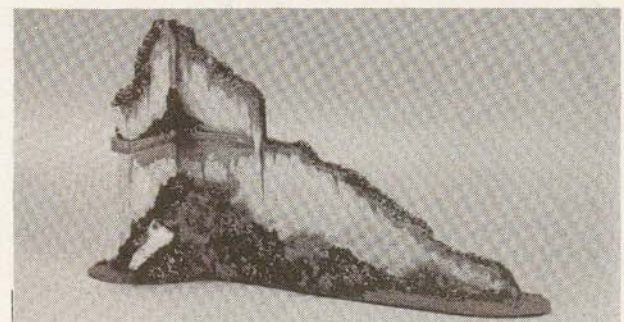

To make a longer corner section of wall, cut out a rectangle 100mm x 150mm and follow the same steps as for the shorter wall. With our longer wall, we squared off one of the sides (see the photo above) to make it look like it had been part of a section with archways, although there is no reason why you can't keep both sides as they are.

ARCHWAYS

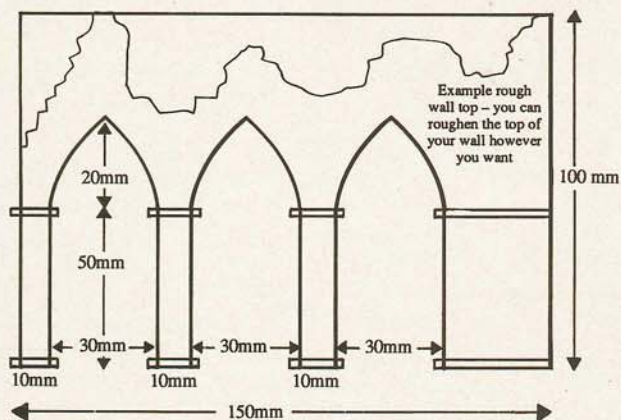

To build the corner section containing the archways follow the same basic steps as for the previous corner sections. However, for this section, one of the walls (it doesn't matter which) should be cut and shaped as in the diagram above.

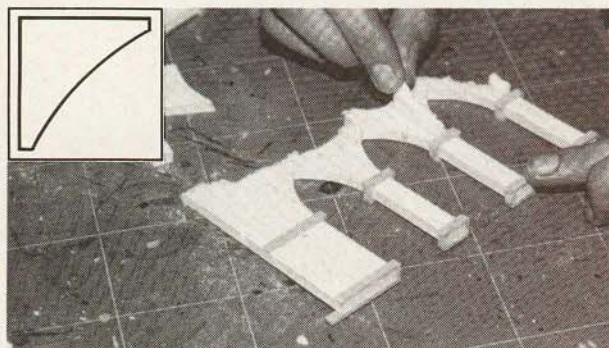

Once you've cut the shape of the arches, roughed the wall top and fixed the decorative ledges, you're ready to add some ruined buttresses. Cut the basic triangle shape shown above from foam card and attach it to the wall above the ledge on each of the pillars. It's entirely up to you how much you 'ruin' the buttress.

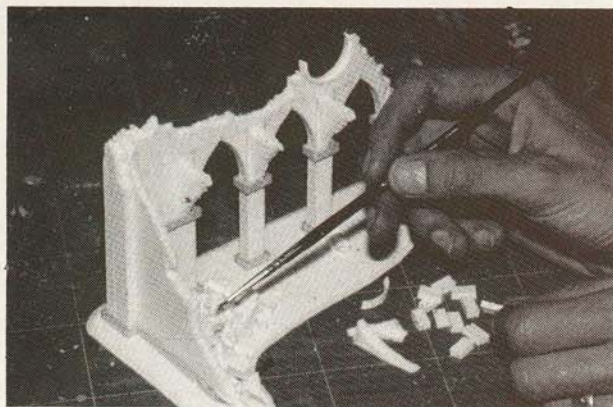

We decided to add further detail to this section by fixing a broken window frame to the top of the wall. This was simply made by using a plastic tab from a Citadel paint pot (the bit that you have to tear off before you open the pot).

The paving stones are small squares cut out of thin card and stuck onto the base before the PVA and coral sand was used. More rubble was added to the base of the wall using the same method as before.

THE ALTAR

For the altar, you'll need:

5mm Foam Card
Coral Sand
All Purpose Glue
All-Purpose Filler

Mounting Card
Scenic Scatter Material
PVA Glue

You'll also find the following useful:

Half Round Plastic Tubing
Thin Plastic or Card Strips

Plastic Shields

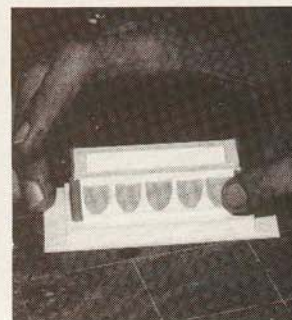
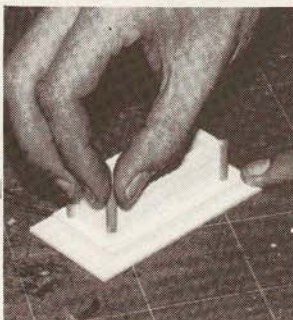

Assemble the altar following the diagram. Note that although the base is made from mounting card, the rest of the altar is made from foam card. If you want, the lid can be left loose so you can open it. The pillars of the altar are made by fixing 5mm half round plastic tubing to each of the corners. Further decoration can be added by using plastic shields (we used the Marauder Miniatures ones with raised emblems) spaced between strips of 1.5mm thick balsa wood. A thinned wash of Tetrion can be painted over the whole structure to give it a stonework effect as well as covering any joints or cracks.

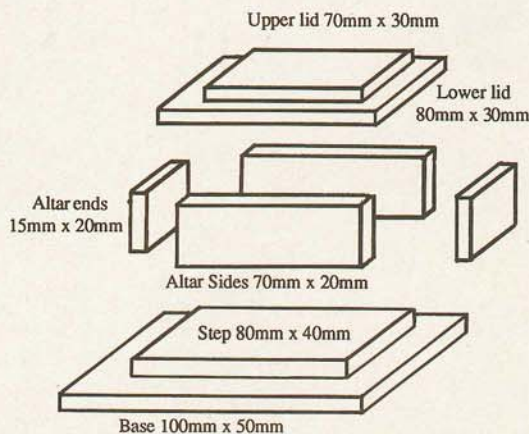

Using the exploded diagram above as a guide, cut all the pieces for the altar out of foam card.

THE PILLARS

For the pillars, you'll need:

- Plaster Wedding Cake Decorations
- Coral Sand
- Scenic Scatter Material
- PVA Glue

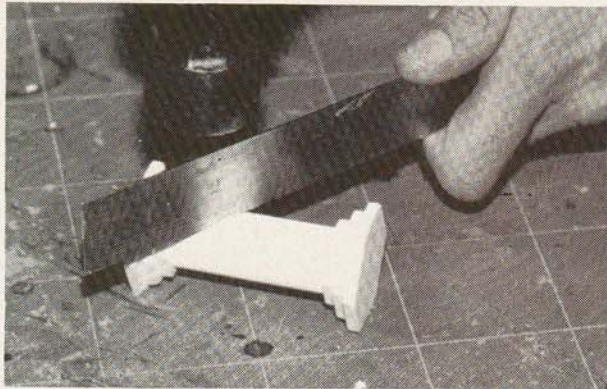

Take the plaster pillars and carefully break them into two at different heights. We found the best way to do this is to place the edge of a steel ruler at the chosen point and give it a short light tap with a hammer. Remember you'll make two broken pillars for every cut you make. Don't use plastic pillars as these will shatter when you cut them rather than breaking with the desired rough edge.

Once you've broken the pillars, fix them to bases of mounting card and add rubble as described for the walls.

PAINTING

Any appropriate light colour is ideal as a base coat for these ruins. We've used Skull White with a little Elf Grey added. Once this is dry, paint on very thin washes of green (coming down the walls to represent lichen and algae) and brown (going up to represent mould). For our green washes we used various combinations of Green Ink, Woodland Green and Goblin Green mixed with a tiny amount of Hobgoblin Orange to dull the green slightly. A useful tip here is to begin by painting around the area you're going to stain with clean water and keep the first washes well within this area while the water is still wet. This makes the wash bleed into the clean water at the edges, diluting the wash even more and giving a nice gradual lightening of colour.

We painted the rubble a darker colour to contrast with the walls, using a Bestial Brown/Chaos Black base colour mix, drybrushed with Orc Brown and finally drybrushed with a mix of Orc Brown and Skull White.

The altar has been painted by starting with a base coat of Chaos Black/Elf Grey, and then drybrushing with a Skull White/Bestial Brown/Ghoul Grey mix. If you change the proportions of these colours for different parts of the altar, you'll get a good weathered effect. Once dry, this was stained as described before.

Finally, the bases of all the structures have been painted with a mixture of Goblin Green/Sunburst Yellow and then drybrushed a slightly lighter green by adding more Sunburst Yellow to the original mix.

TOOLS AND MATERIALS

We used the following tools and materials to make our ruined temple. They're all easy to buy and fairly cheap. If you have a problem finding any of these items, ask the staff at your Games Workshop store for the best place to find them locally.

Wherever possible, we've listed alternative materials – these are usually things that you can find lying around your house. Although we use the materials mentioned in the article, we know it's not always easy to get hold of some of these items. It's perfectly alright to substitute other materials and use whatever you've got to hand.

Modelling knife with replaceable blades (remember to work with new sharp blades – these are much safer than blunt blades).

Steel ruler (a plastic or wooden ruler will be ruined in a very short time).

5mm foam card – a thin sandwich of foam between card sheets, available from art and graphic suppliers at around £6.00 for a 800mm x 1000mm sheet. Alternatively, you can use polystyrene ceiling tiles from DIY and hardware shops.

Mounting card can be bought at art shops for around £1.50 for a 500mm x 800mm sheet. A sheet of **cardboard** will do if you can't get mounting card – the thicker the better.

Balsa wood in a sheet about 1.5mm thick, available from model shops. Again, a sheet of **card** could be used instead.

Plaster wedding cake decorations cost around £2.50 for 4 from department stores.

Coral sand is available from pet shops – a big bag costs about £3.00. Any sort of **coarse sand** or **grit** will do just as well.

Scenic scatter material – small pieces of coloured foam, available from model shops at about £1.00 per bag (or you can make your own by shredding some **foam** or **polystyrene**).

Plastic shields, either Citadel Miniatures or Marauder Miniatures, available from Games Workshop stores and Games Workshop Mail Order.

Half round plastic tubing – semicircular section plastic tubing available from model shops at about 60p for 300-400mm. Or you could cut a large **plastic straw** in two.

Thin plastic strips, available from model shops – or use **slivers of thin card**, which work just as well.

All-purpose glue suitable for card, plastic, balsa wood etc, available from model or stationery shops.

PVA glue – the white glue used for woodworking, available from DIY stores and hardware shops.

All-purpose filler, such as Tetrion or Polyfilla, available from DIY and hardware shops.

SAFETY FIRST

It's worth reminding you that modelling tools can be dangerous if they're carelessly used. Remember, they're sharp and they cut – and it's so much easier to make these models if you've still got fingers.

The most important safety rule is: **make all cuts away from your fingers**. It's much safer to cut through a sheet of card with several light strokes than with one heavy stroke. You're far more likely to slip when pressing too hard so you'll find that you actually get a much straighter cut with light strokes.

Always use a new sharp blade – sharp blades are a lot less dangerous than old blunt ones which you have to press very hard to cut through anything.

If you're unsure of what you're doing, then ask for some help, especially if you're a young modeller.



FREEBOOTERZ

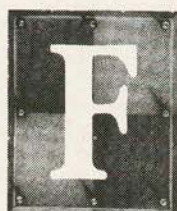
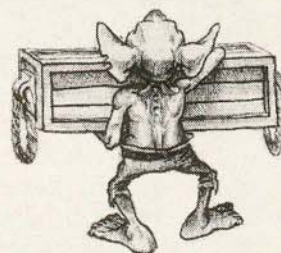

Freebooterz are Orks who have abandoned their tribes to form roving bands of outcasts. The composition of Freebooter bands varies greatly depending on their origin and history. Some are fugitives from Ork society, others eccentrics, while some will be the remnants of shattered armies. A lot of Freebooterz are very treacherous and unpleasant characters

indeed and not the sort of individuals that would be tolerated in normal Ork society. Many of the Freebooterz are available for hire as mercenaries, others are easily persuaded to join in a battle with promises of loot and a good fight.

Freebooterz forsak their old clan allegiances and wear a distinctive style of dress to emphasise this. Even though an Ork may once have been a Goff or a Death Skull, once he becomes a Freebooter he no longer holds any loyalties for his old clan. To emphasise his identity as an outcast, a Freebooter may wear stripy trousers and may decorate himself with ear/nose rings and Jolly Ork tattoos. Being a pretty rough lot Freebooterz are forever fighting amongst themselves, so most of them have scars, eye-patches, and even the sorry reminders of more severe injuries such as missing limbs. Because they don't always have access to Painboyz and Mekboyz, missing limbs are often replaced with crude peg-legs and hook arms, although this is only a temporary measure until the Freebooter can buy or steal himself something better.

Freebooter Kaptins are extremely tough and aggressive Orks with fiery tempers. They command tremendous loyalty from their Boyz, who not only don't object to their bullying and violent ways but actually expect their commanders to behave in this fashion. The Kaptin's occasionally murderous outbursts serve only to impress the Boyz and remind them what a fine leader they have. Kaptins dress in an even more flamboyant style than Freebooter Boyz, favouring large decorated hats and voluminous coats in which they conceal numerous weapons and flasks of Fungus Rum (a particularly potent and indigestible kind of Ork Brew favoured by Freebooterz - it can also be used as fuel in emergencies).

The universal symbol of the Ork Freebooterz is the Jolly Ork - an Ork Skull and Crossbones design which they paint on



their flags, clothes and vehicles. Each Kaptin makes up his own version of the Jolly Ork theme so that he can be identified on the battlefield and so that the enemy know who they are up against. Often the Kaptin will fix upon a conspicuous and well known feature of his own to add to the Jolly Ork design - for example a spectacularly bearded Ork might add a spiky beard to his Jolly Ork flag, while a Kaptin notoriously armed with a unique Kombi Weapon might include a picture of the weapon on his flag.

FREEBOOTERZ FOR HIRE

Freebooterz can be included in an Ork Warband as described in the Army Lists. If the player wishes to include a Freebooter Mob in his Warband he first rolls a D100 to determine what kind of Freebooterz offer themselves for hire. If the player does not have appropriate models to represent the Mob he has generated, then the player should roll again until he obtains a Mob of Freebooter Pirates or any other Mob for which he has models. As the player is allowed to re-roll in this way he can always field a Mob of Freebooter Pirates if he wishes. Freebooter Pirates are the most common type of Freebooter. Once a player has generated a Mob for one battle he may always include that same Mob in future Warbands because the Freebooterz are still in the area and can be hired again.

D100 FREEBOOTERZ MOB

01-15	Freebooter Pirates
16-20	Stormboyz of Khome
21-25	Outcast Oddboyz
26-30	Renegade Mekaniaks
31-35	Renegade Runtherdz
36-40	Bad Docs
41-45	Flash Gitz
46-50	Gretchin Bandits
51-55	Outcast Retinue
56-60	Renegade Speed Freeks
61-65	Wildboy Outlaws
66-70	Bad Ork Bikeboyz
71-75	Weirdboy Wartheadz + Madboyz
76-78	Dreadmob
79-83	Freebooter Minderz
84-88	Ork Chaos Renegade and Retinue
89-91	Ork Mutants
92-94	Possessed Warthead
95	Ork-Genestealer Brood
96-100	Human Mercenaries

Freebooter Pirates. The most common Freebooterz of all are the Mobz of Pirates or Banditz which roam from settlement to settlement in search of a good scrap and plenty of loot. They are led by an especially roguish Kaptin who affects a colourful and distinctive style of dress often featuring a large Kaptin's 'At with the Jolly Ork symbol painted on it.

Stormboyz of Khorne. These are mature Stormboyz who have taken their cult of military virtue to the extreme and begun worshipping the Chaos Power Khorne as patron of their warrior code. They are no longer immature, posturing juveniles laughed at by older, tougher, Orks behind their backs. These Orks are really hard and no mistake!

Outcast Oddboyz. A motley crew of Oddboyz who have been thrown out of their tribe, or who have deserted their homes to take up a life as Freebooterz. Many Oddboyz earn themselves the disapproval of their fellow Orks for one reason or another - a Painboyz might lose one too many patients, a Mekboyz's new Kombi-Weapon may blow up in the face of the Warboss, a Runtherd might be chucked out for being too soft with the Runtz and leading them into bad ways.

Renegade Mekaniaks. Meks from different tribes meet during the Waa-Orks and pool their skills to build Gargants and other weapons for the Waa. Some of these bands lose touch with their original tribes, or their households are wiped out in action, and so they remain together, hiring out their technical expertise to Warbosses who want them.

Renegade Runtherdz. Runtherdz become very protective towards their Runtz and sometimes cannot bear to part with them - which is bad news when other Orks want Runtz for Shokk Attack Teams or to clear mine fields. Sometimes a Runtherd will run away from his tribe rather than see his charges wasted in this way.

Bad Docs. These are dangerous, untrustworthy and deranged Painboyz, whose 'eksperimentz' have resulted in the other Orks throwing them out of the tribe. Now they offer their services to unscrupulous Warlords. They are accompanied by Ork henchmen whose brains have been transplanted with Squigs.

Flash Gitz. These Freebooterz have struck it lucky and are now considerably well equipped as well as being dressed in a completely over the top manner even by Freebooter standards. They literally drip with jewels and war gear ornamented in the richest and most ostentatious way possible. They are a real hard fighting, dangerous mob and a right bunch of show-offs.

Gretchin Bandits. All Gretchin really want to hang around with their Ork masters and prove just how good they are. To this end those Gretchin that can afford to do so arm themselves with simple firearms and follow the Boyz Mobz into battle. The Boyz hate this and find the Gretchin's constant mimicry a real pain in the neck. It is quite common for the Orks to get so fed up that they 'accidentally' forget to tell the Gretchin next time they break camp, and the poor old Gretchin wake up to find themselves abandoned. The Gretchin adapt by seeking out Warbands that will allow them to fight alongside, and they soon develop a quite distinct and independent character as Freebooterz.

Outcast Retinue. An ousted Warboss and his personal retainers sometimes find themselves distinctly out of favour when a new, younger, and meaner Warboss takes over the tribe. The old Warboss and the toughest Nobz from his household have little choice but to leave the tribe and fend for themselves as disinherited Freebooterz.



Renegade Speed Freeks. Speed Freeks have wholly given themselves over to the Ork Cult of Speed - their tribal loyalties are naturally eroded as they immerse themselves in a world of fast machines, engines, and dangerous acts of bravado. Many Speed Freeks abandon their tribes and set-up with others of their kind as daring, speed mad, cut-throat Orks riding an assortment of souped up Hot-Rods.

Wildboy Outlaws. These are Wildboyz who have been found by Freebooterz before a 'civilised' tribe could get to them. Introduced to the rough end of Ork Kultur, they have learned some really bad ways.

Bad Ork Bikeboyz. These are the ultimate Ork Speed Freeks, addicted to the sensation of speed and the noise of battle. They ride huge, low-slung bikes adorned with gleaming paintwork and carefully polished chrome.

Weirdboyz Warpheadz. These are Weirdboyz whose minds have been permanently unsettled by contact with the warp and the horrendous and definitely un-Orky things that live there. They are accompanied by a psychic circus of barmy Madboyz.

Dreadmob. Building Dreadnoughts requires the cooperation of a Mekaniak and a Painboyz. Some find that they enjoy the challenge so much that they devote the lives to building, repairing and hiring out these Gretchin driven machines.

Freebooter Minderz. If yer needz protekshun and yer got da teef ter spare call on 'Da Management,' if yer knows wotz gud for yer.

Ork Chaos Renegade. An Ork Kaptin who has thrown in his lot with one of the Chaos Gods and become a Chaos Champion. He is accompanied by his Chaos Warband.

Ork Mutants. Ork mutants lurk on the fringe of Ork society and just want to be among 'da Boyz' again. A courageous Warlord may employ their undoubted fighting talents if he can tolerate their freaky appearance.

Possessed Weirdboyz. Weirdboyz sometimes become possessed by daemons from the warp. This is a tragedy for both parties, as daemons find it completely impossible to supplant the single-minded Ork personality. The daemon becomes trapped and helpless in the Ork's mind, having realised his mistake and desperate to escape. As for the Weirdboyz... he talks to himself a lot.

Ork-Genestealer Hybrids. The Green Brood, shunned by any proper Orks, but hired by Warbosses with the lowest cunning. Orks are not the best host for the Genestealers because their life-cycle is too slow to suit the alien's purpose. The Patriarch is determined to lead his band to where they can find a new and more suitable host species.

BAD DOCS

Not content with fixing bioniks and mending the wounded with rivets, some Painboyz are tempted into all kinds of deranged experimentation. Some breed strange kinds of blood-sucking squigs (the so-called 'vampire' squigs) which they use as leeches to bleed patients and suck out pus from festering wounds. Others milk venom from snakes and spiders and there are those who go rather too far when tinkering with patients unfortunate enough to be wounded in the head. Eventually other Orks become suspicious when the number of patients who have had their brains replaced by a squig increases, or a frighteningly large proportion of wounded Orks become Madboyz soon after the bandages are off their heads. Soon no one trusts these Docs to do anything, even at a knockdown price. The Doc may be forced to ply his trade elsewhere as his reputation plummets and other Orks avoid him. He will meet others of his kind, sharing his interest in eksperimentz, and another cell of the insidious cult of Bad Docs is born. However, there are depraved Warbosses only too pleased to hire a band of crazy Painboyz, especially those who are trying to hold down the tribe or a subject population, because Bad Docs tend to be expert interrogators.

Bad Docs are accompanied by a retinue of squig-brained Orks, who have little option but to follow the Doc after the operation, since they lose most of their ability to think for themselves or cope without the Doc's guidance. The Doc of course benefits from this retinue of devoted and mindless Orks who protect him, since they are pathetically devoted to their master and not at all lacking in brute force or aggression (especially if the brains of ferocious carnivorous squigs were transplanted into their heads). Bad Docs are often seen riding in a sort of sedan chair carried by four squig-brained retainers. The brain-transplant is not the last eksperiment that the unfortunate retainers have to experience, for they are frequently the guinea-pigs for any of the Doc's lunatic bionik inventions.

FOR 75 POINTS

1 BOSS DOC ARMED WITH FLAK ARMOUR, A BOLTGUN OR BOLT PISTOL (CHOOSE WHICH YOU WANT), A SUITABLE HAND WEAPON (SUCH AS A KNIFE, CLUB OR SWORD).

AND

UP TO 2 APPRENTICE PAINBOYZ ARMED WITH FLAK ARMOUR, A BOLTGUN OR BOLT PISTOL (CHOOSE WHICH YOU WANT), A SUITABLE HAND WEAPON (SUCH AS A KNIFE, CLUB OR SWORD).

AND

A RETINUE OF 5 SQUIG-BRAINED ORK FOLLOWERS ARMED WITH FLAK ARMOUR, A BOLT GUN OR BOLT PISTOL (CHOOSE WHICH YOU WANT) A SUITABLE HAND WEAPON (SUCH AS KNIFE, CLUB, SWORD).

AND

ANY NUMBER OF EXTRA SQUIG-BRAINED ORK FOLLOWERS AT 4 POINTS EACH

	M	WS	BS	S	T	W	I	A	Ld	Int	Cl	WP
BOSS DOC	4	5	4	5	5	2	4	1	8	9	8	7
APPRENTICE PAINBOYZ	4	4	3	4	4	2	3	1	7	8	7	7
SQUIG-BRAINED ORKS	4	3	2	6	6	2	2	2	3	3	8	3



OPTIONAL WARGEAR: Bad Docs are able to buy or exchange equipment from the profits of their Freebooting. If you want you may generate equipment from the charts indicated below. Choose any chart and randomly generate a bit of equipment for the points indicated. You can roll as many times as you like on as many charts as you wish, and any items generated may be distributed among the Mob as required. Any equipment not used must still be paid for; it is assumed to be left at home and may be used in future games.

CHART	COST PER RANDOM ROLL	CHART	COST PER RANDOM ROLL
ASSAULT WEAPONS	5	BIONIK BITZ	5
STIKKBOMZ	5	KUSTOM WEAPONS	25
POWER FIELDS	5		

GEAR FOR SQUIG-BRAINED ORKS. Bad Docs can also buy extra gear for their Squig-brained Ork Followers. All followers may be equipped with the item indicated at the cost indicated. For example, a single roll on the Assault Chart for 5 points could give all the Squig-brained Orks a Chainsword.

CHART	COST PER RANDOM ROLL
ASSAULT WEAPONS	5
PAINBOYZ BIONIK BITZ	UP TO D3 BITZ FREE

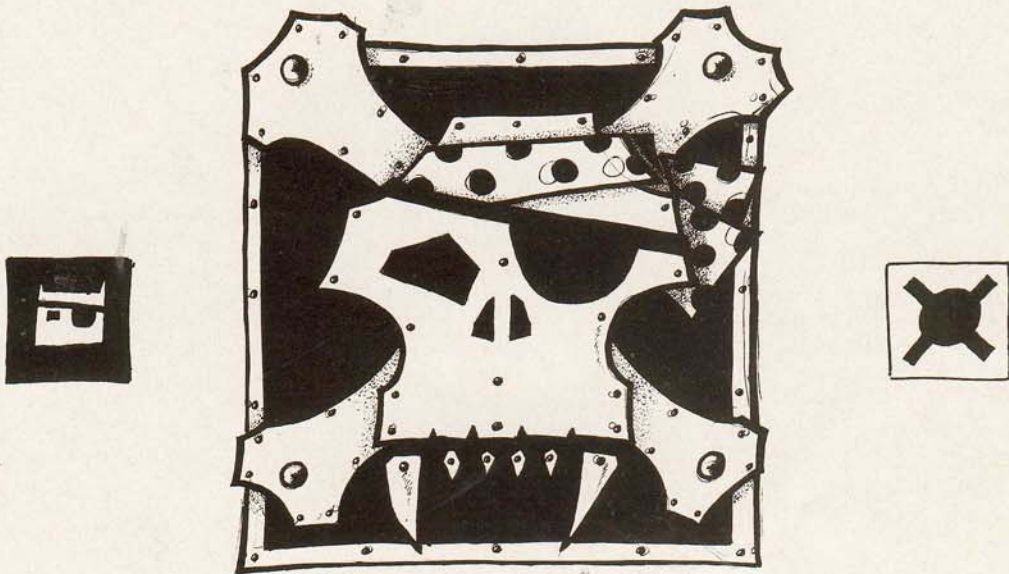

SPECIAL RULES FOR SQUIG-BRAINED ORKS. The brain of a squig was never intended to cope with the same stresses and strains of life as an Ork, so it's not surprising that Squig-brained Orks are subject to occasional bouts of confusion. Any time that one of these rolls a 1 on any dice roll, for whatever reason and whatever the result, it also means that he has suddenly become confused. Virtually anything, from frustration to random noises could trigger this reaction. Once confused, the Ork wanders at half his normal rate in a random direction, and will attack any model he is touching during the close combat phase on a D6 roll of 4 or more. He won't shoot any weapons except in close combat. This means he may well end up attacking other Orks and even other Squig-brained Orks! Once confused, the Squig-brained Ork doesn't bother with unit coherency but moves as a rather dazed individual. The Ork remains confused for the rest of the game - but will come round in time for the next game if he survives.

SQUIG-BRAINED DREADNOUGHT: The Bad Doc's Mob may include 1 Dreadnought chosen from the Freebooter Oddbitz List. However, this is no ordinary Dreadnought but a Squig-brained Dreadnought. Although it hardly bears thinking about, some Mad Docs are sufficiently crazed to experiment with using Squigs instead of Gretchin to control a Dreadnought. Naturally the result is rather extraordinary - one minute you're a big fat Squig settling down for a kip in the drops and the next thing you know you're a fifteen foot high metal fighting machine festooned with potent weapons of destruction. It's hardly surprising if the Squig-brained Dreadnought tends to behave a bit erratically! Every turn the Squig-brained Dreadnought moves D6" in a direction nominated by the Ork player - however if a 1 is rolled it instead moves D6 inches in a random direction. If the Dreadnought moves into a model it will fight it on the D6 roll of a 4 or more, whether the model is a friend or foe (the Squig can't tell the difference anyway). If the Dreadnought is armed with weapons it can fire in the shooting phase, then roll for each weapon. On the score of 4, 5 or 6 the Dreadnought fires that weapon in a random direction. It doesn't matter which way the Dreadnought is facing - it's probably spinning round a bit anyway as the Squig tries to cope with its inexplicable transformation.

ATTENDANTS: The Bad Docs can be accompanied by unarmed and non-combatant Gretchin and Snotling orderlies, some of which may have been experimented on by their masters. The Bad Docs always make sure they have a good supply of Squigs carried in big jars by Gretchin servants.

ORK GENESTEALER HYBRIDS

Orks are not an ideal host race for Genestealers and eventually any Genestealers who infect them will realise that the Orks are a dead end as far as the prospects for furthering the Genestealer species is concerned. Ork society is not structured like Human society and the sophisticated techniques of infiltration around a secure power base will not necessarily work. Sometimes Genestealers find that they must infect Orks simply because no better hosts are available. Orks find and board drifting space hulks and delve into deserted ruins which are exactly the sort of places where Genestealers might lurk. If the Genestealer has been waiting for centuries to infect a host and a party of just happen to Orks turn up, the Genestealers will simply follow their instinct to procreate their race. They are just unlucky it was Orks!

Sometimes, albeit rarely, a Genestealer-Ork hybrid brood grows and prospers. Genestealer broods are usually only successful once a breeding community of Wild Orks has been infected. If a 'civilised' community is infected, it has a catalytic effect on the Ork breeding urge (due to the influence of the Genestealer gene) and Ork hybrids occur eventually, but usually the Genestealer incursion simply dies out. It is very rare for the brood to survive long enough for Purestrains to emerge, and then there are few. This is because the Ork life cycle simply does not favour the propagation of a Genestealer Brood. Orks do not breed until the end of their lives and so the development of a brood is very slow. Also hybrid whelps are unlikely to be adopted by the 'civilised' Orks. A Patriarch who realises his mistake will tend to use the Ork brood as a temporary stage in making contact with more suitable hosts.

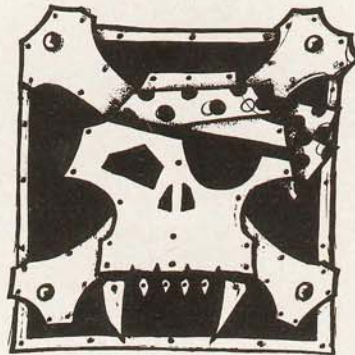

A brood that does begin to thrive, and has sufficient technology to be of use to the Patriarch in spreading the gene further into the universe, is also likely to make contact with other Orks. When surrounding tribes notice that there is 'sumfink wrong' with the brood tribe, that they are 'not proper Orkses' and have been 'taken over by da Bug-eyez', they will probably wipe them out pretty quickly. Thus prospects are bleak for an Ork hybrid brood even if they go over to Chaos worship in a desperate effort to survive, since Chaos, like Genestealers is also of little threat to the Ork race as a whole. Occasionally Hybrid bands are encountered wandering on the fringes of Ork society wondering what they can do about their predicament. This Mob represents just such a group, who might be recruited by a Warboss of exceptional low cunning to unleash against his most bitter enemy.

The chart below lists the characteristics of Ork Hybrids of different generations. The natural colouring of the Genestealer is pinkish-mauve with bluish-purple carapace. Ork hybrids tend to gain a greenish hue as the generations progress until the fourth generation, which are very much like genuine Orks.

GENERATION	FIRST	SECOND	THIRD	FOURTH
HEAD	Bulbous	Bulbous	Bulbous	Orkoid
BODY	Carapace	Carapace	Crouched	Orkoid
LEGS	Long	Long	Orkoid	Orkoid
ARMS	4	3 or 4	2 or 3	2
FANGS	Yes	Yes	Yes	Ork teeth
CLAWS	Yes	Yes	Yes	Ork hands
OVIPOSITOR	Yes	Yes	Yes	No
HYPNOTIC GAZE	Yes	Yes	Yes	No
TELEPATHY	Yes	Yes	Yes	Yes
PSYCHOLOGY	Immune	Immune	Immune	Immune

HEAVY WEAPONS: The Boy with a heavy weapon can have any weapon chosen from the list below. Extra points are paid for this weapon so it's up to you how much you spend.

WEAPON	COST FOR WEAPON	WEAPON	COST FOR WEAPON
AUTO-CANNON	35	MULTI-MELTA	50
HEAVY BOLTER	15	FRAG MISSILES	1
HEAVY PLASMA GUN	75	KRAK MISSILES	20
HEAVY STUBBER	10	MELTA MISSILES	4
LAS CANNON	90	SMOKE MISSILES	1
MISSILE LAUNCHER	30		

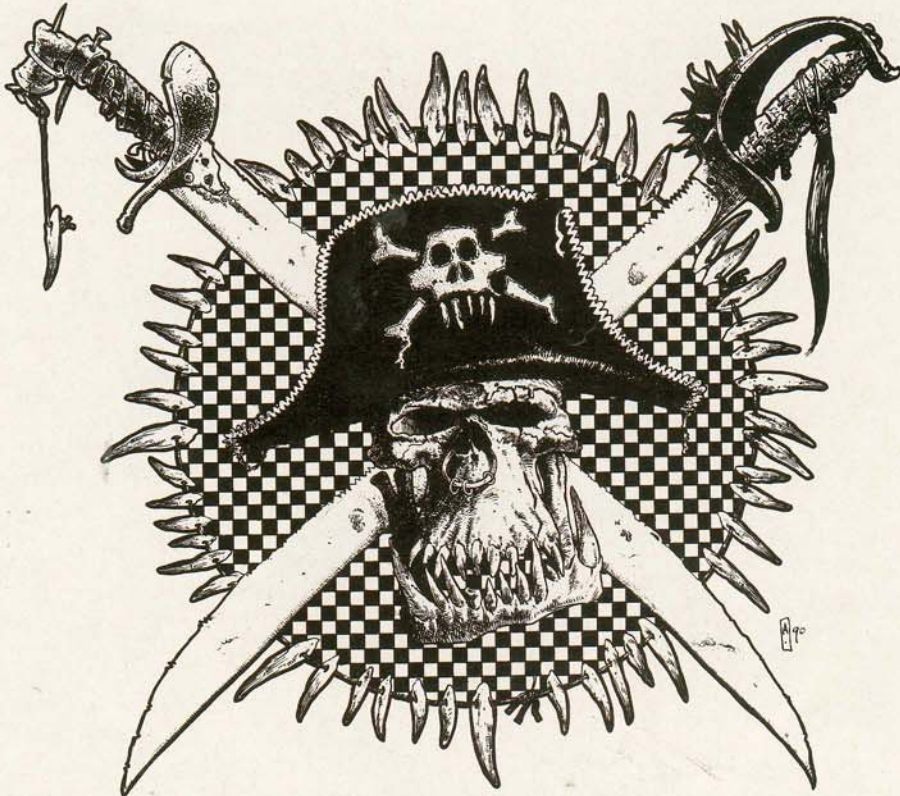

EXTRA WARGEAR: The Mob can be exceptionally well armed due to the loot captured in many battles and raids. The Boyz equip themselves pretty much to their taste, with all kinds of exotic and expensive gear. To represent this the player may roll as many times he wishes on any of the charts listed below, paying the points cost indicated for each roll. The gear generated in this way may be distributed among any of the Flash Gitz as you please. You may decide not to use the gear you generate, in which case it is left behind in the Mob's stash, but you must still pay the points for it. Naturally any of this reserve equipment can be used in future games.

CHART	COST/ROLL	CHART	COST/ROLL
RANGED WEAPONS	5	FORCE FIELDS	10
ASSAULT WEAPONS	5	BIONIK BITZ	10
HEAVY WEAPONS	50	KUSTOM WEAPONS	10
STIKKBOMZ	5		

Any of the Flash Gitz may also wear Powered Armour or carry extra Bolt Pistols at the cost noted below.

BOLT PISTOL	1
POWERED ARMOUR	6

VEHICLES: The entire Mob may ride in a Battle Wagon free of charge - a Flash Gitz Battle Wagon is always painted in the most spectacular manner and adorned with trophies and mementoes of past successes. Any weapons generated on behalf of the Mob may be fitted to the Battle Wagon if you wish.

ATTENDANTS: The Flash Gitz need lots of servants to carry the masses of gear they have. The Mob is accompanied by any number of non-combatant Snotlings and Gretchin. Even the Flash Gitz Runtz drip with pendants and jewels, with carefully engraved teeth studs, and all kinds of snazzy decoration. The Runtz are excessively proud of their wealthy masters and delight in showing off their posh gear to other less fortunate Grotz.

ORK GENESTEALER HYBRIDS

Orks are not an ideal host race for Genestealers and eventually any Genestealers who infect them will realise that the Orks are a dead end as far as the prospects for furthering the Genestealer species is concerned. Ork society is not structured like Human society and the sophisticated techniques of infiltration around a secure power base will not necessarily work. Sometimes Genestealers find that they must infect Orks simply because no better hosts are available. Orks find and board drifting space hulks and delve into deserted ruins which are exactly the sort of places where Genestealers might lurk. If the Genestealer has been waiting for centuries to infect a host and a party of just happen to Orks turn up, the Genestealers will simply follow their instinct to procreate their race. They are just unlucky it was Orks!

Sometimes, albeit rarely, a Genestealer-Ork hybrid brood grows and prospers. Genestealer broods are usually only successful once a breeding community of Wild Orks has been infected. If a 'civilised' community is infected, it has a catalytic effect on the Ork breeding urge (due to the influence of the Genestealer gene) and Ork hybrids occur eventually, but usually the Genestealer incursion simply dies out. It is very rare for the brood to survive long enough for Purestrains to emerge, and then there are few. This is because the Ork life cycle simply does not favour the propagation of a Genestealer Brood. Orks do not breed until the end of their lives and so the development of a brood is very slow. Also hybrid whelps are unlikely to be adopted by the 'civilised' Orks. A Patriarch who realises his mistake will tend to use the Ork brood as a temporary stage in making contact with more suitable hosts.

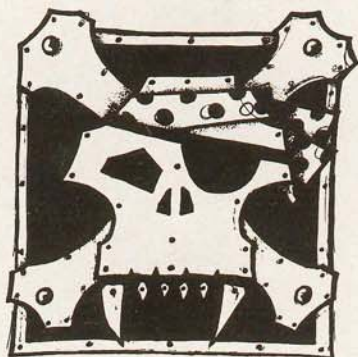

A brood that does begin to thrive, and has sufficient technology to be of use to the Patriarch in spreading the gene further into the universe, is also likely to make contact with other Orks. When surrounding tribes notice that there is 'sumfink wrong' with the brood tribe, that they are 'not proper Orkses' and have been 'taken over by da Bug-eyez', they will probably wipe them out pretty quickly. Thus prospects are bleak for an Ork hybrid brood even if they go over to Chaos worship in a desperate effort to survive, since Chaos, like Genestealers is also of little threat to the Ork race as a whole. Occasionally Hybrid bands are encountered wandering on the fringes of Ork society wondering what they can do about their predicament. This Mob represents just such a group, who might be recruited by a Warboss of exceptional low cunning to unleash against his most bitter enemy.

The chart below lists the characteristics of Ork Hybrids of different generations. The natural colouring of the Genestealer is pinkish-mauve with bluish-purple carapace. Ork hybrids tend to gain a greenish hue as the generations progress until the fourth generation, which are very much like genuine Orks.

GENERATION	FIRST	SECOND	THIRD	FOURTH
HEAD	Bulbous	Bulbous	Bulbous	Orkoid
BODY	Carapace	Carapace	Crouched	Orkoid
LEGS	Long	Long	Orkoid	Orkoid
ARMS	4	3 or 4	2 or 3	2
FANGS	Yes	Yes	Yes	Ork teeth
CLAWS	Yes	Yes	Yes	Ork hands
OVIPOSITOR	Yes	Yes	Yes	No
HYPNOTIC GAZE	Yes	Yes	Yes	No
TELEPATHY	Yes	Yes	Yes	Yes
PSYCHOLOGY	Immune	Immune	Immune	Immune

FOR 60 POINTS
1 PURESTRAIN GENESTEALER PATRIARCH

AND

1 FOURTH GENERATION HYBRID ARMED WITH BOLTGUN OR BOLTPISTOL (CHOOSE WHICH YOU WANT) AND A HAND WEAPON (SUCH AS A KNIFE, CLUB OR SWORD).

AND

1 THIRD GENERATION ARMED WITH BOLTGUN OR BOLTPISTOL (CHOOSE WHICH YOU WANT), AND A HAND WEAPON (SUCH AS A KNIFE, CLUB OR SWORD).

AND

ANY NUMBER OF SECOND GENERATION ARMED WITH BOLTGUN OR BOLTPISTOL (CHOOSE WHICH YOU WANT), AND A HAND WEAPON (SUCH AS A KNIFE, CLUB OR SWORD) AT 10 POINTS EACH.

PLUS

ANY NUMBER OF FIRST GENERATION HYBRIDS ARMED WITH BOLTGUN OR BOLTPISTOL (CHOOSE WHICH YOU WANT), AND A HAND WEAPON (SUCH AS A KNIFE, CLUB OR SWORD) AT 15 POINTS EACH.

PLUS

ANY NUMBER OF PURESTRAIN GENESTEALERS AT 40 POINTS EACH.

PLUS

ANY NUMBER OF ORK BOYZ WEARING FLAK ARMOUR AND ARMED WITH A BOLT GUN OR BOLT PISTOL (CHOOSE WHICH YOU WANT) AT A COST OF 7 POINTS EACH.

	M	WS	BS	S	T	W	I	A	Ld	Int	Cl	WP
FOURTH GEN. HYBRID	4	3	3	4	4	1	4	1	7	8	7	8
THIRD GEN. HYBRID	4	4	2	4	4	1	3	1	6	7	6	7
SECOND GEN. HYBRID	5	5	1	5	4	1	4	2	7	6	7	7
FIRST GEN. HYBRID	6	6	1	6	4	1	5	3	8	6	8	7
PURESTRAIN	6	7	0	6	4	2	7	4	10	7	10	8
PATRIARCH	6	7	0	6	5	2	7	4	10	8	10	9
ORK BOY	4	3	3	3	4	1	2	1	7	6	7	7

EXTRA WARGEAR: The player may generate any amount of extra wargear from the charts below, paying the points shown for each roll. Due to the difficulties Genestealers have in trading and interacting with ordinary Ork society these rolls cost a lot more than they do for some other types of Freebooter. Any of this equipment may be distributed between the third and fourth generation hybrids and Ork Boyz as you wish. Other Hybrids and Purestrains may not carry these weapons. Any weapons not used may be left in the Genestealers' stash, but must still be paid for. This equipment may be used in future games if the player wishes.

CHART	COST PER ROLL
ASSAULT WEAPONS	10
STIKKBOMZ	10
FORCE FIELDS	15

CHART	COST PER ROLL
BIONIK BITZ	25
KUSTOM WEAPONS	30

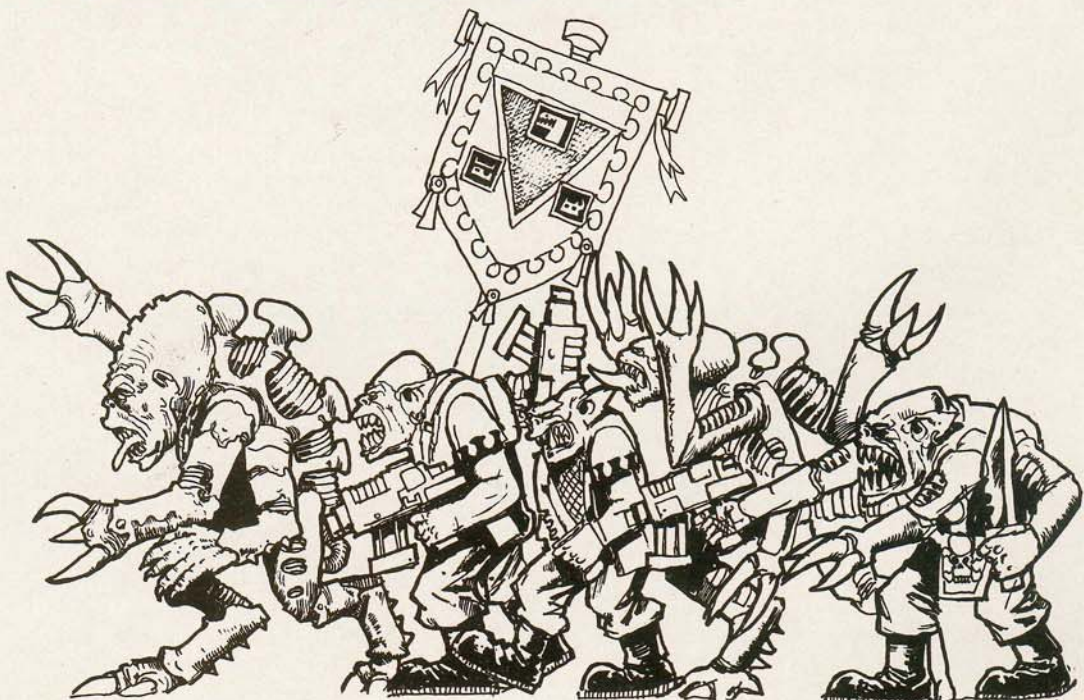

GAMES WORKSHOP™

MODELLING GUIDE



Citadel Miniatures make more models than anyone could possibly paint and field on a wargames table. Even so, there may be certain models that you need to complete your army that Citadel haven't made yet. Or, as many people do, you may wish to field a unit that is completely individual or is just simply fun to create. To get these unavailable or individual miniatures, you need to convert some of your existing miniatures.

Converting miniatures is fun and it isn't as difficult or as expensive as you might imagine. Everyone has miniatures that they never get around to painting or playing with – and every plastic set that Citadel make leaves you with extra bits. These can form the basis of what we call a bits box, a great resource for conversions. And, of course, our Mail Order department can supply you with any part or any model that we make, metal or plastic, large or small.

Although in this issue we tell you how to use various tools for modelling and converting, all you need to start are a pair of cutters or nail clippers, a small file, a modelling knife, a tube of superglue, some plasticine and a pencil or wooden cocktail stick. I can honestly say that I've never used any tools more sophisticated than these when creating individual miniatures. But, there again, I'm known for my minimalist approach – I'd much rather spend my money on new models and get started right away! Like I said, converting miniatures is great fun.

GETTING STARTED

You'll probably already have plenty of ideas about the miniatures you'd like to convert for the wargames units you're collecting. Perhaps you've got a miniature that you want to use as a champion but you'd like him to hold another weapon – or perhaps you've rolled up a custom weapon for an Ork Nob and you want to make a suitably over-the-top Mek-built extra-shooty gun.

In this article we describe how we converted the models for some of our own wargames units and we describe the tools and techniques used. This should give you plenty of ideas for how to convert models for your armies.

Most of the tools we describe can be bought from your local Games Workshop store. If you can't get to a Games Workshop, you'll find similar tools in most hobby stores, such as model railway shops. DIY and hardware shops are also a good source for tools and modelling materials.

If you have any difficulty finding the tools we've described, or you want some help with modelling techniques, the friendly staff at your local Games Workshop store will be only too pleased to help. All our staff are enthusiastic gamers and modellers and they'll be able to give you useful tips.

Also at your Games Workshop store, you'll find regular converting and painting clinics where local modellers show you all the techniques you'll need. These often include a hands-on session, where you can take along your own models and get expert advice to help you solve any problems.

Look at the store's noticeboard or phone the store to find out the date of the next modelling event – and keep an eye on the Games Workshop Store News in White Dwarf for announcements of special events.

Every month in White Dwarf, there are modelling and painting articles where we explain how some of our own models were converted and painted. These are full of useful hints and tips that you'll find invaluable in helping you with your own conversions.

SAFETY

When you're converting miniatures, always have safety in mind – it's all too easy to slip and hurt yourself if you're not paying attention. But with a little care, and using well-maintained tools, you should be perfectly safe.

Knives and saws should always be kept clean and sharp – a sharp blade is much safer than a blunt one. Any cutting should be done away from your fingers and preferably down onto a solid surface. A cutting mat is the best thing to work on but these are quite expensive; a thick piece of card will do just as well. Make sure you don't cut directly onto a table.

Whenever you're using glue, work in a well-ventilated area; if you don't the fumes can be dangerous. Be particularly careful with superglue – not only can you stick your fingers together, but the fumes can affect the eyes and lungs. You should also be careful about what you let glue drip onto as it can remove furniture polish if it soaks through absorbent surfaces such as paper and card.

And always keep your work area clean and tidy – there's nothing more annoying than cutting a delicate part off a miniature and losing it amongst the mess on your desk!

In this guide we cover the techniques and tools we've found useful for converting Citadel Miniatures. But for every tool and technique there's always an alternative – if you've got a different way of doing something, that's fine. In fact, if you've got any handy modelling tips that you think might be worth passing on to other gamers, why not write in and let us know. Write to:

Modelling Tips
Games Workshop Design Studio
Enfield Chambers, 14-16 Low Pavement
Nottingham NG1 7DL

We won't be able to reply individually to all your letters, but we'll certainly read them with interest and we'll pass on any good tips in future issues of White Dwarf.

TZEENTCH CHAOS WARBAND

MODELLED AND PAINTED BY DALE HURST



This Chaos Warband was dedicated to Tzeentch, the Lord of Change, because I wanted a colourful unit painted in the typical Tzeentch colours of blue and purple with strong yellow and red decorations. I wanted to give full rein to my passion for converting Citadel Miniatures and including unique models as part of my wargames armies. Chaos warbands are perfect for this because their

mutations give me plenty of scope for creative modelling while the small number of models involved means I can finish the warband off ready to play fairly quickly.

As I wanted to get them on the wargames table as soon as possible, I kept the painting simple, restricting myself to blocking out the different areas in solid colour and adding black lining to bring out the definition between the colours. Once I'd blocked in these areas of colour, the warband was ready to fight – in fact, I fought a couple of battles using the warband before I even got around to putting on the black lining. As you can see, this warband shows that you can create a really striking and effective unit that looks great on the tabletop without spending hours painting every model. Even if you decide to add highlights and shading, you can play a game with the models as soon as you've got the basic solid colours painted on. You'll have plenty of time between battles to add more detail if you want to – though, of course, it's perfectly fine to never go any further than a simple block colour scheme if that's all you want to paint.

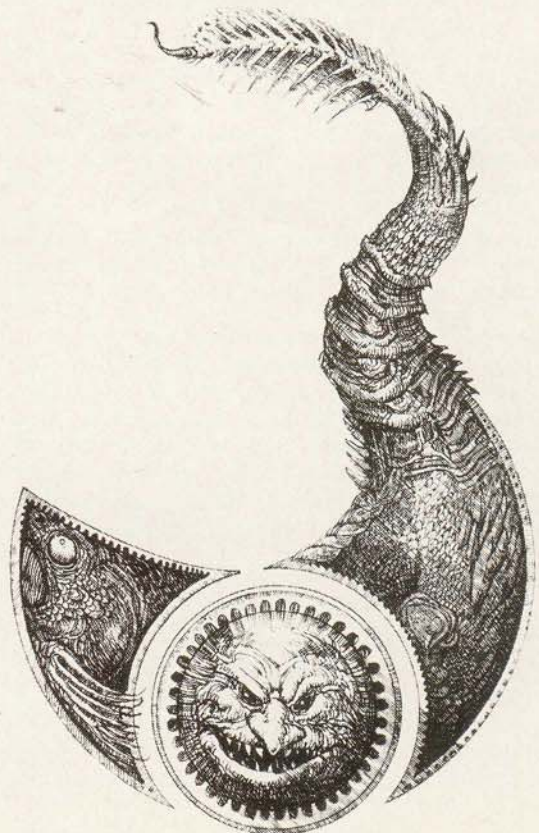

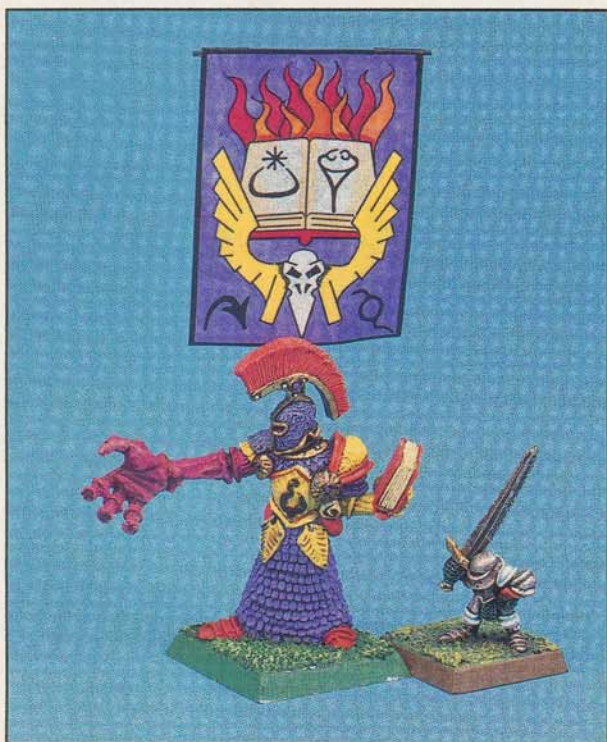

For Mutarchus, Champion of Tzeentch and leader of the warband, I combined parts from three miniatures. I chose the body of one Tzeentch Champion and the head from another. I wanted the body of a Champion holding a spell book to fit with Mutarchus' Gift of Magic and I liked the idea of the crested helmet to tie in with the image of flames I'd decided to use for Mutarchus' banner. I also added the arm from a Horror to match another of Mutarchus' gifts, his Hand of Tzeentch.

The first stage in converting this model was to assemble the parts. I snipped the head and right arm off the body I was using with a pair of cutters, and then cut the new head and the Horror arm off their bodies. I didn't want to take a chance on damaging the new head, so I used a fret saw to get a more accurate cut.

Before I continued, I put all the pieces I wasn't using into my bits box where I keep all my spare model parts, ready to be used for future conversions.

To assemble the model, I decided to pin the head and arm to the body to give the joints greater strength. This is a technique I'd recommend when you're joining together two large parts but it's not essential for small parts. I could have just glued the head and arm in place but, because the model's probably going to get some fairly rough handling on the wargames table, I decided not to take any chances and really make sure the joints held.

Once I'd assembled my Champion I painted it with a striking combination of blue, purple, red and yellow and finished it off with a banner.

We've included a black and white copy of the banner here so that you can photocopy and paint it for your own models. I attached the banner to a stiff wire pole by folding the tabs at the top over the cross-piece and gluing them to the back of the banner. Finally, I drilled a small hole in the model's back and superglued the pole in place.



You can photocopy this banner to paint for use on your own Champion of Tzeentch

CUTTING MODELS

There are three tools that are handy for this: a pair of cutters, a fret saw and a modelling knife. You'll certainly need cutters and a modelling knife for any conversion work – a fret saw is a bit of a luxury and you shouldn't be put off converting if you haven't got one.

Cutters are great for snipping off small parts of models such as arms, legs, weapons and heads. Electrician's wire cutters or nail clippers are fine for this sort of work – it's best if they have a straight edge to give a clean cut. Don't use scissors or cutters with blades that overlap as they'll twist your miniature out of shape while you're cutting it.

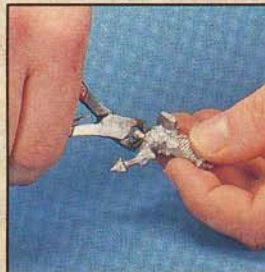

Removing a head with cutters



Removing a head with a fret saw

If you're removing larger areas, or if you want to make sure of an accurate cut, it's better to use a fret saw. You'll find a fret saw is preferable to a hacksaw because it allows you to change direction when you're sawing so you get a more accurate cut. Always take great care when using a saw. Make sure you've got a sharp blade and don't put too much pressure on the blade – it may snap if you're too violent with it.

You shouldn't use a modelling knife for cutting pieces off miniatures as you'll have trouble getting a clean cut and there's a chance the blade will snap and fly off dangerously! A modelling knife is fine, however, for trimming small areas of excess metal or plastic. Always cut away thin slivers rather than make one deep cut as this is both safer and neater.

When you're cutting with a modelling knife, only use new sharp blades. Old blunt blades are more dangerous – you have to press harder and they're likely to snap off. Always cut away from your fingers and cut down onto a suitable surface like a cutting board or a sheet of card – don't go cutting big holes in your dining room table!



I gave the two Chaos Thugs head swaps to match their Bestial Face mutation. The eagle heads are particularly appropriate for followers of Tzeentch, echoing one of the Power's symbols and the head of a Lord of Change – you'll note that I've also used an eagle's skull as one of the images on Mutarchus' banner.

I prepared these conversions by cutting the heads off the Thug miniatures and then cutting the two replacement heads from eagle models. Once I'd removed the heads from the Thug torsos, I filed the surfaces to be joined until I had a smooth finish. I decided that the eagle necks gave me a large enough area for gluing to not require pinning so I made sure I got a good clean fit between the heads and the torsos. As you can see from the photo, I used the flat side a needle file. Needle files are small modelling files that come with flat and rounded sides. When you're filing a join smooth, try to keep your filing action straight and level so you don't produce a rounded finish.

Once the two parts fitted snugly, I applied a small amount of superglue to the stub of the Thug's neck – just enough glue to cover both parts but not so much that it would spill out all over the rest of the model. I pressed the two parts firmly together and held them in place for a few seconds to let the glue harden.



Remember when you're using superglue that it's strong and fast-acting stuff – try to keep it on the things you're about to stick! The most important thing with superglue is to make sure you don't get any in your eyes by accident – I always keep a rag handy to clean my fingers after I've glued the models together.

The only other change I made to these Thug models was to move their shields round so they faced more to the front – I wanted the designs to show clearly when they were on the tabletop. This was simply a matter of cutting away the shield bosses from the models' arms using a pair of cutters or a fret saw and then using a file to clean up the finish. The shield was then glued into its new position with superglue. If you're gluing onto an area of the model that's a bit rough, file the area smooth before gluing to make sure there's a clean surface for the glue to stick.

PINNING JOINS

To pin a join you simply drill a small hole in both parts of the model and then place a piece of thick wire into the holes when the model's glued. The wire reinforces the glue and stops any sideways shift of the join. A good pinned join will be just as strong as an unconverted model. We definitely recommend pinning when you're adding large parts though it's by no means essential for small parts.

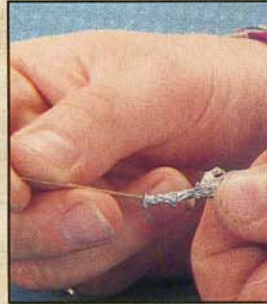

Gluing the pin into place

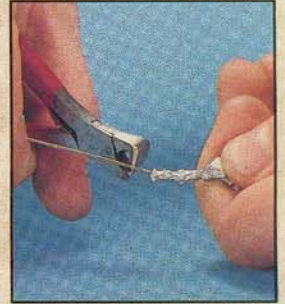

Cutting the wire to the correct length



Gluing the arm into place



The finished join

To drill the holes, you'll need a pin-vice and some small drill bits. A pin-vice is a miniature hand-operated drill that's perfect for fine work like this. You'll also need some thin stiff brass wire to fit into the holes you're going to drill. If you can't get hold of brass wire, thick fuse-wire, dress-making pins or paper-clips will do just as well.

Before drilling any holes, make sure the two surfaces to be joined fit together properly. If they don't, file them smooth until you've got a good, neat fit. A small file known as a needle file is best for this – you can get needle files with both flat and rounded sides.

Use your pin-vice to drill a shallow hole into the centre of one of the surfaces to be joined – we find that a hole about 5-6mm (1/2") deep is best. Insert a short length of wire, slightly longer than the hole itself so that the top just pokes out. Line up the other piece of the model and gently press the two together. The point of the wire marks where to drill into the second piece.

When you've drilled the second hole, put in a longer section of wire – this should be just long enough to fill both holes when the model is assembled. Now you can superglue the two pieces together – hold them in place for a few seconds until the glue sets.



With the four Beastmen, I chose to use the same basic miniature to get a strong unit feeling but converted each of the miniatures to give it an individual head. Citadel Miniatures are sold in blister packs containing assorted miniatures but if you want a unit all made up of the same miniature you can order them from Mail Order – you can get as many of the same model as you want. As we've already seen, head swaps are really easy to do and you can have great fun choosing and positioning the new heads. Because they're quick conversions, I was able to make use of this technique for all the models I've described so far. Even so, if I was working on a larger unit, say 10 or 20 models, I wouldn't dream of converting every one like this – at most, I'd change just a few models so the unit looked like it was made up of individuals. It's surprising how just a small number of little changes can have quite a large visual impact on the tabletop – with a bit of thought, you'll find that simple changes to two or three miniatures can make all the difference. Of course, with the huge range of Citadel Miniatures available, you'll often be able to field a varied but consistent unit without having to do any conversions at all.

For three of the Beastmen, I swapped their heads with animal heads taken from a Citadel Miniatures Chimera. I used exactly the same technique here as we've already described for the two Thugs. Again, I felt the surfaces to be joined were large enough for pinning to be unnecessary so the parts were simply cleaned up with a flat needle file and superglued into place.

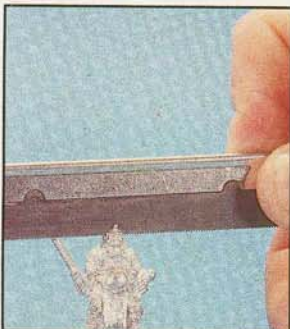

Carefully removing the head with a saw



The finished conversion

I used the head of a plastic Citadel Miniatures Skeleton to give the fourth Beastman its Skull Face mutation. I cut away the face of the Beastman with a razor saw. A razor saw is a small stiff-bladed saw without the flexibility of a fret saw. It's just as useful as a fret saw for cutting away largish pieces of a model provided there's nothing in the way – because a fret saw has a thin blade held at each end you can cut on the other side of arms, for example, by slipping the saw over the arm.

Once the front of the Beastman's head was removed, I filed the surface smooth with a needle file. To prepare the Skeleton's head, I simply trimmed away some of the plastic at the back with my modelling knife until I had a flat surface to glue to the Beastman. The two parts were joined with superglue which is just as good for sticking plastic to metal as for gluing two metal parts.

When I painted the Beastmen, I reinforced my use of the same basic miniatures by painting them in identical colour schemes, keeping their armour, tunics etc to the blue, yellow and red colours I'd chosen for the warband. Notice how the Beastmen's shields match those carried by the Thugs, and that they all echo the prominent flame symbol on Mutarchus' banner.



For this splendid winged Minotaur, I used the wings from the same Chimera that provided the Beastman heads. To fix the wings in place, I used the pinning and gluing technique I've already covered. Because the wings are quite heavy, I used a longer pin than before – I wanted to make sure the wings stayed in place as the model was moved around.



Drilling a hole for the wings



Gluing the wings into position

Once both wings were in position, I used plasticine to hide the joint, shaping it so that it looked like a hump of muscle at the base of the wings. I pushed roughly the right amount into place with my fingers and then used a cocktail stick to get it into the cracks and shape it.

FILLING GAPS

Sometimes when you're joining two parts of a model you'll find that you've got a largish gap between them. For these joins, it's easier to fill the gap rather than file the parts until they fit. The best thing for filling gaps is plasticine. Roll out a thin sausage of plasticine and wrap it around the join. Then use a modelling tool, cocktail stick, or the point of a pencil to spread out the plasticine and make a smooth join. If you've used too much, simply scrape off the excess to avoid an ugly bulge.



If you want, you can sculpt detail into the plasticine.

If you're joining two areas of chainmail or fur, for example, you could sculpt the plasticine to match the surrounding texture.

This is quite easy to do with a modelling tool, cocktail stick, blunt pin or the end of a pencil.

Once your plasticine is in place, give it a thin coat of superglue – this seals the plasticine hard.

Finally, I painted the wings blue and yellow in keeping with the colours of the rest of the warband, and painted a black and white zebra pattern on the Minotaur's body for its Brightly Coloured Skin attribute. These zebra strips are very eye-catching but really simple to paint – just black wedges painted over the white undercoat of the model.

The last model in the warband is a Chaos Spawn. This is ideal for modelling and is the miniature that I spent most time on. Chaos Spawn can be wildly mutated and there are endless possibilities for their appearance, so it's impossible for Citadel Miniatures to make a range of Spawn. This means that if you're putting together a Chaos warband that contains one or more Chaos Spawn you've got a chance to really go to town with a conversion and give full rein to your strangest visions. And it doesn't have to be a complicated model – two or three very weird changes will make it look totally unique, such as moving the head to another part of the body, giving it multiple arms or legs, mixing limbs and bodies from different models. Roll up a few Chaos Spawn from the charts in Realm of Chaos and you'll see what I mean – they'll all look radically different.

If you've got a large bits box with plenty of remnants from earlier conversions, you'll already have an excellent resource for Chaos Spawn parts. If not, you can order any Citadel Miniatures parts through our Mail Order Service. The wide range of multi-part models are perfect for this. You don't have to order whole models – provided you know which part you want, you can order just a head or an arm or whatever. All the separate part numbers are listed in the Citadel Catalogue (see the pages at the end of this magazine for an example of how models are numbered). Of course, you can only order a head if it's cast separately, not if it's cast as part of a whole model!

My Chaos Spawn had to match the attributes that I'd rolled up for it. This still left me with plenty of leeway to decide exactly how it looked. With some imaginative interpretation of its attributes, I ended up with this very strange-looking creature.

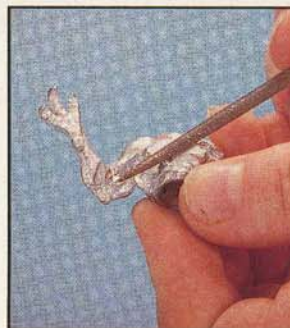

Filling the chest flat



Drilling a hole for the head of a Horror



Gluing the Horror head into position



Gluing the head into position



Drilling holes for the legs



Gluing the legs into position

The model started with the head and torso of a Minotaur Lord. To this, I added a Dragon's tail for the left arm. You'll notice that in the conversion photos, I used the 'sting' of a plastic Tyranid Warrior for the left hand – I decided that this didn't look as good as I'd hoped and replaced it with the Dragon's tail to create a great-looking whip-like tentacle.



To the Minotaur's chest, I attached the head of a Horror, turned upside-down for a weird appearance with the mouth above the eyes. And to make it even weirder, I replaced the Horror's arm with plastic Skeleton heads. Finally, I used four Horror arms for the Chaos Spawn's legs giving it a sort of crabby-spiderly look.

All of these parts were pinned and glued, just as I've already described. Any gaps in the joins were filled with plasticine and smoothed over to make the join invisible. As you can see, although there's quite a lot of parts to this conversion, and it took a little bit of thought to pose it right, the modelling techniques are no more difficult than used elsewhere in the warband.

To finish my Chaos Spawn off, I painted it with the warband's main colours of blue, purple, yellow and red – notice how Mutarchus' flame motif appears once more on the Spawn's armoured shoulder plate. It's this sort of simple but important detail that gives the warband such a strong impression of cohesion. Look again at the photo of the whole warband – despite the huge differences in appearance between the various models, it's immediately obvious that they all belong to the same unit. On the tabletop, nobody's going to be in any doubt as to whose warband they're facing!

I picked a Tzeentch warband for several reasons. One was the chance to paint a unit in a strong colour scheme with lots of bright primary colours. Another was that I'm playing in a Chaos warbands campaign at the Design Studio. I rolled up my Champion's starting profile and got a level 10 wizard – as the most magical of the Chaos Powers, Tzeentch was the obvious choice for a patron. We'd decided that all new warbands were going to begin with a Mighty Champion, so that determined the number of rewards and followers I was going to receive and the unit's points value of 400. I'm also putting together a Slaanesh army and, when I've got enough Slaanesh units with basic paint schemes ready to start playing, I'm intending to use this warband as an allied contingent.

I've only played a couple of games with the warband as yet, so I'm still refining my tactics, but here's a rough idea of how I intend to deploy the warband. The Beastmen, Thugs and Chaos Spawn form a line of attack with the Beastmen in the centre and the Thugs being sent against the weakest enemy flank. I send the Chaos Spawn against the stronger enemy flank, hoping to break it and move on to attack the centre – the Chaos Spawn has a good speed to move around the table and with 7 Fear Points it stands a reasonable chance of routing enemy units. The winged Minotaur, Doomgore, is my strongest warrior and is sent against the enemy Champion. With a flying speed of 11" and a Weapon Skill of 10, he can get into combat fast and do a lot of damage.

Mutarchus himself is my most potent character. I use him to weaken the enemy with magic as the two warbands close and then get stuck in to hand-to-hand combat if necessary. He's got Chaos Armour and a magic sword with frostblade and parrying abilities – this means he's going to take some beating. Even so, I try to keep him out of the way of really powerful opponents, leaving them to Doomgore.

Mutarchus, Champion of Tzeentch – Level 15 Chaos Sorcerer

M	WS	BS	S	T	W	I	A	Ld	Int	Cl	WP
4	5	3	4	4	3	4	1	9+2	9+2	9+2	9+2

Chaos Armour, Magic Sword – Frost Blade, Parrying. Attributes: Arm of a Flamer, Blood Substitution, Familiar – Combat, Gift of Magic.

Combat Familiar:

M	WS	BS	S	T	W	I	A	Ld	Int	Cl	WP
4	6	0	5	5	1	6	2	10	2	10	10

Doomgore – Level 10 Minotaur Hero

M	WS	BS	S	T	W	I	A	Ld	Int	Cl	WP
6	10	4	5	5	4	4	4	10+1	5	7	6

Light Armour, Magic Mace – Enchanted Wound. Attributes: Brightly Patterned Skin – Zebra, Weapon Master, Wings – Min Speed 2", Max Speed 11", Acc/Dec 6".

2 Chaos Thugs

M	WS	BS	S	T	W	I	A	Ld	Int	Cl	WP
4	4	4	3	3	1	4	2	7	7	7	7

Light Armour, Shield, Hand Weapon. Attributes: Bestial Face – Eagle, Rapid Regeneration.

4 Chaos Beastmen

M	WS	BS	S	T	W	I	A	Ld	Int	Cl	WP
4	4	3	4	5	2	3	2*	7	6	7	6

Light Armour, Shield, Hand Weapon. Attributes: Bestial Face – Snake (poisonous bite), Ram, Boar, Skull Face (*1 attack only).

Chaos Spawn

M	WS	BS	S	T	W	I	A	Ld	Int	Cl	WP
6	4	3	4	4	3	3	2	9	5	7	6

Attributes: Hand of Tzeentch, Horrible Stench, Limb Loss – Legs, Limb Transference – Arms to Hips, Manikin, Multiple Arms, Rearranged Face, Rune of Tzeentch, Tentacle, Vividly Coloured Skin. 7 Fear Points.

BANNERS

There are three basic types of banner pole: a straight pole with the banner hanging from the side; a pole with a right-angled bend giving a horizontal bar from which to hang the banner; and a T-shaped pole, giving a double-width horizontal bar for really large and splendid banners.

Banner poles should be made from stiff wire. Straight and right-angled poles are easily made from a single piece of wire, with or without a bend in it. The most impressive banners hang from T-poles with a central upright and a cross-piece at the top.

For this you simply need to glue two lengths of wire together. First, mark a point on the centre-pole where the cross-piece is to join. Then, using a round needle file, cut a shallow rounded groove just big enough for the wire to fit in. This increases the gluing surface of the two wires and makes a much stronger join.

Wrapping fuse wire around the join once it's fixed helps to strengthen the bond and looks just like rope if you paint it in the appropriate colours. Once you've put the banner pole together, the next step is to draw and paint the banner itself and fix it to the pole.

We've already published a huge range of banner designs in White Dwarf and our game rulebooks, both as colour versions and as black and white outlines. All you need to do is photocopy the outlines and colour them in with Citadel Paints, using the colour banners as guides.

Using the ready-drawn banners is a great quick way to come up with finished designs. Once you're used to working with these, you'll want to start designing your own banners as well. First roughly sketch out the design that you want, then draw it out neatly and paint in the appropriate colours. You don't have to stick to paper to paint on – why not try to metal foil. Foil is useful because it allows you to bend it into folds to get a feeling of movement and of wind blowing against the banner. All you have to do is give it a coat of white paint before you start as this gives you a good surface to draw your design on.



When you're cutting out your banners, make sure you leave a few long tags to attach the banner to the pole. These are on the side for straight poles, and on the top for right-angled and T-poles. Once you've finished the banner, bend the tabs over the pole and glue them back onto themselves.

You can add any amount of decoration and adornment to the pole. For example, skulls and severed heads look good on Chaotic or Goblinoid standards, whereas eagles are more appropriate for Empire banners.

You can make smaller versions of all these sorts of banners for individual characters in your armies, such as Ork Nobz or unit commanders. You make these in just the same way as the larger banners. Drill a small hole in the back of the model and superglue the pole in place.



ORK-GENESTEALER HYBRIDS

Ork-Genestealer Hybrids, known as the Green Brood, are shunned by proper Orks and only hired by Warbosses with the lowest cunning. Orks are not the best host for Genestealers because their life-cycle is too slow to suit the aliens' purpose. The Patriarch of a Hybrid Freebooter mob is therefore determined to lead his band to where they can find a new and more suitable host species. Here we describe how we modelled and painted Zodgog's Brood, a typical Hybrid Freebooter mob.

A unit of Ork-Genestealer Hybrids is a good subject for converting as it contains a whole range of variants from Purestrain Genestealers through Hybrids of various generations, down to pure-blooded Ork Boyz. The readily-available plastic parts for Orks, Genestealers and Hybrids give you lots of potential variants and plenty of scope for simple but effective modelling.

The Ork-Genestealer Hybrids section of the Ork Freebooter list has a table that tells you what the Hybrids of different generations look like. It gives you details of the appearance of a Hybrid's head, body, legs, arms, fangs and claws. Using this table as a guide, you can work out how Orky your Hybrids will look – a first generation Hybrid is very close a Purestrain Genestealer in appearance whereas a fourth generation Hybrid looks almost like a normal Ork.

PAINTING THE HYBRIDS

The Patriarch, Purestrain Genestealers and first generation Hybrids have all been painted using shading and highlighting. The rest of the mob have simply had the main areas blocked out in solid colour with black lining between colours and in areas of deep shadow.

Even though all the models haven't been painted with shading and highlights, the unit's ready to field in a game of Warhammer 40,000. When you're building an army you want to get your models onto the tabletop as soon as possible. We always start gaming with models once they've been given their basic colour schemes. Anything more detailed is left for later when we've got enough models painted to play and there's time to go back and add extra detail to heroes, champions and other character models.

The green flesh colour of the Orks was darkened with blue the nearer the Hybrid was to a Purestrain (so first generation Hybrids are the bluest). The basic Ork flesh colour is a 50/50 mix of Bilius Green and Goblin Green with Enchanted Blue added as required to darken the mix. We experimented with mauve colouring for the Hybrid's heads but found this made them look rather false and unrealistic. Instead we opted for an overall green-blue colour on heads and limbs, though you'll notice there's mauve dappling on some of the heads to unify the colouring of the Hybrids with that of the Purestrain Genestealers.

We used Enchanted Blue for tunics and trousers to complete the Genestealer feel. Typical Genestealer wedge-shaped decoration was painted on to tunics and shoulder pads – bright red and white were used for these symbols, in true Orky style.



The Patriarch is a standard metal Citadel Miniatures Genestealer model. We wanted him to stand out from the other two Purestrain Genestealers, so we painted his claws red and painted a white dappled pattern over his head. The two Purestrain Genestealers, also both metal Citadel Miniatures, were painted in the usual Genestealer colour scheme of blue-grey carapaces and mauve areas of flesh.



The first generation Hybrid was based on a metal Purestrain Genestealer model. Its left arms are taken from a Hybrid model. The clawed right arm is from the original metal Purestrain model but the lower right arm is a plastic Ork arm holding a plastic Ork bolter. To fit this arm to the Hybrid, we first trimmed away its sleeve with a modelling knife. When you're cutting away excess material like this, it's best to whittle the arm down slowly by taking off thin slivers of plastic each time. You're much more likely to damage the model or snap the blade if you try to cut it all off in one go.

The arms were fitted by pinning and gluing them into place so that they were holding the bolter forwards in an attack position. We didn't worry too much about the fit at the shoulders and just aimed to get the pose of the bolter correct. Once we were happy with the pose, we filled any gaps with plasticine and then smoothed the plasticine flush using the tip of pencil.

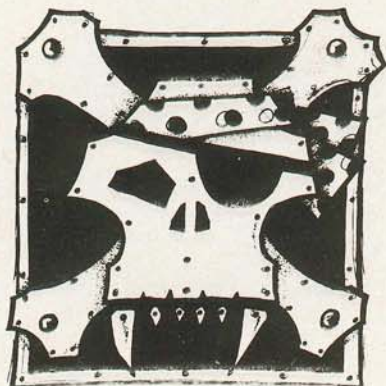

The sword and bolter armed second generation Hybrid is based on a plastic Citadel Miniatures Hybrid model. Its right arms are both plastic Ork arms. Its clawed left arm is a plastic Purestrain arm and below that is a plastic Hybrid arm. The weapons are a plastic Ork bolter and chainsword. We've trimmed all the mechanical-looking workings off the chainsword to make it into a saw-toothed sword.

The other second generation Hybrid has been made using a Plastic Hybrid body and three plastic Ork arms. With both of these models, we trimmed the tops of the arms until we got a comfortable fit at the shoulder. Once they were superglued in place, we filled any gaps with plasticine. The plasticine was covered with a thin coat of superglue – this seals the plasticine hard.



3rd generation Hybrid before filling



Side view showing tunic and shoulder pad decoration



Rear view showing back plate symbol



The finished miniature

The third generation Hybrid was constructed from a metal Ork Freebooter Hybrid model, adding plastic Genestealer Hybrid arms, a plastic Ork bolter and a plastic Ork shoulder pad.

The arms were fitted in the same way as for the earlier generations. This time, to get the pose we wanted, we cut nicks out of the middle of the arms and bent them into the desired position. The gaps were filled with plasticine and then covered with a thin layer of superglue.



Using a pin vice to drill a hole



Inserting a pin and cutting it to the correct length



Drilling a hole in the right arm



Trimming the left arm to fit

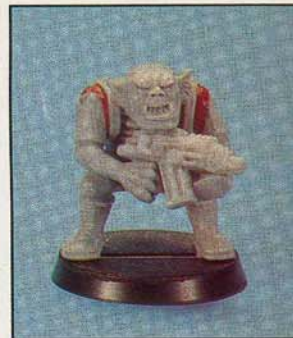

The completed miniatures painted in block colours and lined with black

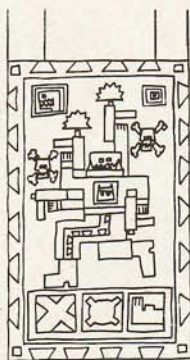

You can photocopy and paint this banner for use with your own Ork Hybrids

For the fourth generation Hybrid, we used a metal Ork Nob model with plastic Hybrid arms. The arms were pinned to the body and then posed as already explained. One arm holds a plastic Ork chainsword, the other a kombi-weapon made by gluing two bolt pistols side-by-side – one side of each bolter was trimmed flat with a modelling knife before gluing them together. The model is finished off with an impressive back banner in Nob tradition. The banner pole is simply a length of thin stiff wire glued into a hole that we drilled with a pin-vice just above the Nob's backplate. Before gluing the cross-piece in place, we filed a small nick out of the middle using a round needle file – this fitted around the vertical pole and gave us more surface area for the glue to hold. To finish the banner pole off we added a plastic Genestealer's claw to the top.

For the two normal Ork Boyz we used standard plastic Ork models. We chose the bald heads to fit in with the look of the Hybrids.

We trimmed the sleeves at the tops of the Orks' plastic arms so that we could position them with both hands holding their bolters. As usual, we filled any gaps with plasticine and sealed it with a thin coat of superglue.

ZODGOG'S BROOD – 264 points

1 Patriarch

1 Fourth Generation Hybrid – chainsword, knife, smoke stikkbombz, bionik bit – targeter eye, kustom weapon
Kustom Weapon – 2 bolt pistols:

Range		To Hit		Sv		C		H		S		F		A	
S	L	S	L	S	D	Sv	C	H	S	F	A	S	F	A	A
8"	16"	+3	+1	4	1	-1	X								

1 Third Generation Hybrid – boltgun and knife

2 Second Generation Hybrids – boltgun (1 with sword)

1 First Generation Hybrid – boltgun

2 Purestrains

2 Ork Boyz – flak armour and boltgun

Zodgog's Brood is a fairly large Ork-Genestealer Hybrid unit because we wanted to include at least one of each generation and two of most. The basic brood at 60 points is only 3 models: a Patriarch, a 4th generation Hybrid and a 3rd generation Hybrid so these were the models that we converted and painted first. This meant we could get the brood into play while working on the other models.

It'll make an interesting unit to play on the tabletop because of the wide variety of characteristics and armaments. These range from the Purestrain Genestealers with their high Weapon Skills and Strengths who'll be excellent in hand-to-hand combat, to the Ork Boyz and 4th generation Hybrid who are better suited to shooting with their boltguns and bolt pistols.

KAPTIN BADRUKK'S FLASH GITZ

Kaptin Badrukk's Flash Gitz are part of the Design Studio's Ork forces. Up till now they've fought as part of our Goff army, Waa-Ghazghkull, but one of the great things about Freebooter mobz is you can use them with any Ork army – just like Freebooter themselves, selling their services to whoever offers the most teef!

We started off with a basic squad of Gitz: Kaptin Badrukk himself plus five Boyz, one of whom carried a heavy weapon. We wanted this mob to be outrageously flash and decided that everybody would have a kustom weapon, including the Boy with the heavy weapon (who'd therefore have to abandon his heavy weapon – though it can be left behind at the mob's base and used in future games if required).

The next stage was to roll on the Equipment Charts to find out what kustom weapons, bionik bitz and so forth our Gitz possessed. We rerolled a couple of the bionik bitz to suit the Freebooter models we had. We were quite happy with whatever we rolled for the kustom weapons – as we were going to convert the models, the more over-the-top and unusual the weapons the better.

Once we'd found out what the weapons were, we looked through our bitz box to see what useful weapon parts we could find – anything we didn't have was ordered as specific part through Mail Order. Based on the stats we'd rolled up, we exercised a bit of imagination to decide what the guns looked like. For example, the heavy plasma gun with +12" range, D6 damage and +2 to hit was obviously a weapon to be reckoned with – we decided this was going to BIG – so big, the Boy holding it needed a Gretchin to hold up the far end.

As soon as we'd got Kaptin Badrukk and his five Gitz modelled and painted in their basic colour schemes we fielded them as part of Waa-Ghazghkull. Their kustom weapons looked great and worked well, if erratically, on the tabletop. In fact, we were so impressed with the Gitz that we got carried away and decided to make some more.

We've played a few games with them now, trying out the mob each time we add a new model. In future games we've got the choice of using some or all of the Gitz depending on the size of the battle.

Kaptin Badrukk and the original five Boyz came to a total of 235 points – with the extra three Boyz (Zodgrot, Gorsnik and Lugwort) the full mob of nine Flash Gitz now totals 321 points.

For details of side effects see the Kustom Weapons rules in this issue.

KAPTIN BADRUKK

M	WS	BS	S	T	W	I	A	Ld	Int	Cl	WP
2	6	5	4	5	3	5	1	9	8	9	8

Flak Armour, Chainsword, Frag Stikkbombz, Peg Leg, Kustomized Kombi-Weapon

Kustomised Kombi-Weapon – 2 Barrels: Boltgun and Heavy Stub

Boltgun: Rate FF, +3 to hit, 2" radius
Heavy Stub: -2 to hit

Barrel	Range		To Hit			S	Dam	Sv	C	H	S	F	Area
	S	L	S	L	S								
Boltgun	0-12"	13-24"	+4	+3	4	1	-1				X		2"
Heavy Stub	0-20"	21-40"	-2	-2	4	12	-1		1"	X	X		

BADGOR

M	WS	BS	S	T	W	I	A	Ld	Int	Cl	WP
2	4	4	3	4	1	3	1	7	6	7	7

Flak Armour, Dagger, Goo-bomb (1), Bionik Bit – Power Glove, Kustom Weapon

Kustom Weapon – Missile Launcher: +4" range, decorated with gaping mouth

2 Side Effects: Armour Buster and Wild Shot

Barrel	Range		To Hit			S	Dam	Sv	C	H	S	F	Area
	S	L	S	L	S								
M Launcher	0-22"	23-76"	*	*	*	*	*	*			1"	X	

* Depends on type of ammunition being fired

SNOTWORT

M	WS	BS	S	T	W	I	A	Ld	Int	Cl	WP
2	4	4	3	4	1	3	1	7	6	7	7

Flak Armour, Dagger, Boltgun, Saw-off Shotgun, Goo-bomb (1), Kombi-Weapon

Kombi-Weapon – 2 Barrels: Multi-Melta and Plasma Gun

Barrel	Range		To Hit			S	Dam	Sv	C	H	S	F	Area
	S	L	S	L	S								
Multi-Melta	0-12"	13-24"	+1		8	4D4	-4		2"	X			2"
Plasma Gun	0-8"	9-24"	+1		7	1	-2				X		

ROTRNOB

M	WS	BS	S	T	W	I	A	Ld	Int	Cl	WP
2	4	4	3	4	1	3	1	7	6	7	7

Flak Armour, Dagger,

Kustomised Kombi-Weapon – 2 Barrels: Multi-Melta and Autocannon

Multi-Melta: -2 to hit, D3 damage, +1 Strength
Autocannon: decorated with gaping mouth

Barrel	Range		To Hit			S	Dam	Sv	C	H	S	F	Area
	S	L	S	L	S								
Multi-Melta	0-12"	13-24"	-1	-2	9	D3	-4		2"	X			2"
Autocannon	0-20"	21-72"			8	D6	-3		2"	X			1"

SKARFANG

M	WS	BS	S	T	W	I	A	Ld	Int	Cl	WP
2	4	4	3	4	1	3	1	7	6	7	7

Flak Armour, Dagger, Frag Stikkbombz, Bionik Bit – Stainless Steel Mandible and Teeth, Kustom Weapon

Kustom Weapon – Heavy Plasma Gun: +12" range, D6 damage, +2 to hit

Side Effects: Overheats and Cloud of Smoke

Barrel	Range		To Hit			S	Dam	Sv	C	H	S	F	Area
	S	L	S	L	S								
Sustained	0-26"	27-62"	+2	+2	7	D6	-2		2"	X	X		1"
Maximal	0-26"	27-84"	+2	+2	10	D6	-6		2"	X			1"

NAZROT

M	WS	BS	S	T	W	I	A	Ld	Int	Cl	WP
2	4	4	3	4	1	3	1	7	6	7	7

Flak Armour, Dagger, Bolt Pistol, Bionik Bit – Bionik Leg, Kombi-Weapon

Kombi-Weapon – 2 Barrels: Boltgun and Lasgun

Barrel	Range		To Hit			S	Dam	Sv	C	H	S	F	Area
	S	L	S	L	S								
Boltgun	0-12"	13-24"	+1		4	1	-1						
Lasgun	0-12"	13-24"	+1		3	1	-1						

ZODGROT

M	WS	BS	S	T	W	I	A	Ld	Int	Cl	WP
4	4	4	3	4	1	3	1	7	6	7	7

Flak Armour, Smoke Stikkbombz, Bionik Bit – Targeter Eye*, Kustom Weapon

Kustom Weapon – Boltgun: 2" radius, infra-red searchlight, decorated with gaping mouth

Barrel	Range		To Hit			S	Dam	Sv	C	H	S	F	Area
	S	L	S	L	S								
Boltgun	0-12"	13-24"	+1		4	1	-1						2"

* Targeter Eye included in Boltgun stats

GORSNIK

M	WS	BS	S	T	W	I	A	Ld	Int	Cl	WP
2	4	4	3	4	1	3	1	7	6	7	7

Flak Armour, Dagger, Bionik Bit – Kustomized Kombi-Weapon Arm, Bionik Bit – Auto-senses

Kustomized Kombi-Weapon – 4 Barrels: 2 x Multi-Meltas, Boltgun, Autogun

Multi-Melta 1: -4" range
Multi-Melta 2: D12 damage
Boltgun: +2 Strength
Autogun: 1" radius, -1 to hit

Side Effects: Jams and Incredible Noise

Barrel	Range		To Hit			S	Dam	Sv	C	H	S	F	Area
	S	L	S	L	S								
Multi-Melta 1	0-10"	11-20"	+1		8	4D4	-4		2"	X			2"
Multi-Melta 2	0-12"	13-24"	+1		8	D12	-4		2"	X			2"
BoltGun	0-12"	13-24"	+1		6	1	-1						
Autogun	0-12"	13-32"	+1		6	1	-1						1"

LUGWORT

M	WS	BS	S	T	W	I	A	Ld	Int	Cl	WP
2	4	4	3	4	1	3	1	7	6	7	7

Flak Armour, Dagger, Kombi-Weapon

Kombi-Weapon – 5 Barrels: Autocannon, 2 x Lasgun, Flamer, Needle Gun

Barrel	Range		To Hit			S	Dam	Sv	C	H	S	F	Area
	S	L	S	L	S								
Autocannon	0-20"	21-72"			8	D6	-3		2"	X			1"
Lasgun x 2	0-12"	13-24"	+1		3	1	-1						
Flamer	0-6"	7-12"	+2	-1	4	1	-2						1/4"
Needle Gun	0-16"	17-32"	+1		3	1	+1				X		

KAPTIN BADRUKK'S FLASH GITZ



Flash Gitz are the flashiest of Freebooterz, flamboyant in appearance and armed to the teeth – and Kaptin Badrukk's mercenaries are no exception. Most of the conversions on these models centre on their weapons – every Ork is armed with a kombi-weapon or a kustom speshul, with a handful of snazzy bitz thrown in for good measure.

Weapon conversions and additions are fast, easy and fun to do. Flash Gitz are good for this sort of modelling work because of their choice of eccentric and exotic weapons. All you need are spare weapons from your bitz box – or you can order extra plastic weapon sprues from Mail Order.

Lengths of thin brass rod are also extremely useful – these are easily available from most model shops at a modest price. The basic models are all Citadel Miniatures Freebooterz. Once you've got your components, all you need to do is clean up the models and extra parts and then glue them together with superglue – it couldn't be easier!

PAINTING THE FLASH GITZ

There's no denying that Badrukk's Flash Gitz look great and present an imposing sight on the wargames table. At first glance, it might seem that the work that's gone into them is really complicated. Actually, it's all been achieved by the use of large banners, striking colour schemes and the check and hoop patterns on the models. The painting itself is simply a single solid coat of the right colours with a thin line of black paint around each edge where two colours join.

There's no highlighting, shading or blending and, as you can see, the effect is more than acceptable for a unit you can use when fighting a tabletop battle.

Once the main areas of colour have been blocked in, the models are ready for gaming. You can add extra detail at a later date if you want, but in the meantime you can field the models as part of your army.

The main colours that have been used are a 50/50 mix of Bilious Green and Goblin Green for the Orks' flesh, Striking Scorpion Green for checks and flags, Go Fasta Red, Ultramarine Blue and Bad Moon Yellow.

We've provided black and white copies of all the banners used by Kaptin Badrukk's Flash Gitz. You can photocopy these and use them on your own Orks if you want. Or use them as a source of inspiration for your own banner designs.

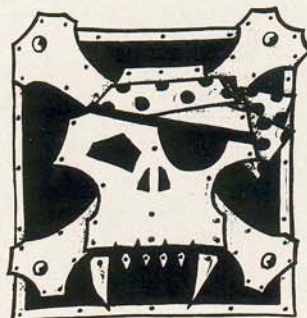



Kaptin Badrukk's gun is a combination of a Ripper Gun from an Ogryn model and a bolter. The original barrel of the Ripper Gun has been cut off and replaced with the front of an Ork bolter. The Ripper Gun barrel has then been glued onto the side of the gun to produce a double-barrelled weapon.

Kaptin Badrukk has three banners because he's very flash – even by the standards of Flash Gitz. All three banners use variants of the Freebooter Jolly Ork symbol. The main colours of a red skull on a yellow background with blue and green bones and guns run as a theme throughout the mob.



Zodgrot is wearing a hat just like Badrukk's – if it's good enough for the Boss, it's good enough for Zodgrot. The hat was cut off another Freebooter model – Zodgrot's head was filed flat and the hat superglued in place.

His weapon is based on a plastic bolter. The animal head end of a plastic Chaos autocannon has been added to the bolter's barrel and a multi-launcher from an Epic scale Knight has been glued on top.

Zodgrot has also been given various extra plastic bits from the Ork sprue (such as pouches and stikk-bombz), as have many of the other Orks in the mob. This is coz they're Flash Gitz and the more bitz they've got the flasher they are.



Lugwort's belt-fed weapon has been constructed from an Epic scale Knight weapon, plastic lasguns, the barrel of a plastic Chaos autocannon with the head removed, and the magazine from a Space Marine bolter. The bullet belt was made by sticking plasticine onto a thin strip of foil and then scoring cartridge shapes into it with a needle. A thin coat of superglue over the top ensures that the plasticine keeps its shape.



An animal head has been added as a snazzy bit to Badgor's gun – this has been taken from the end of a plastic Chaos autocannon. The ammo clip has been sawn off the bottom of Badgor's original gun and glued back on top.

Badgor is Badrukk's sidekick, but he wants to lead the mob himself. To show his independence he's chosen a banner that deviates from the mob's usual design (though notice it retains the red-skulled Jolly Ork).

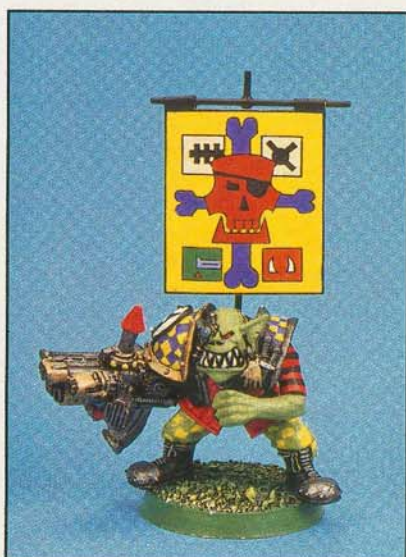

Gorsnik's gun has been constructed from all sorts of spare weapons: a metal melta-gun, bolter magazines, an Epic scale lascannon and the gun from an Epic scale Eldar Knight. The chimney has been cut off Gorsnik's shoulder and added to the top of the gun.

The glyph plate on his right shoulder was simply made from a ball of plasticine that was pressed flat and then glued into place. A thin coat of superglue over the top holds the plasticine in shape.



Nazrot has got a bionik leg. This has been made using the leg from an Epic Knight model with a plastic Space Marine elbow pad fitted at the top to help the bionik effect. When the original leg was removed using cutters, the slotta-base tab was left intact to help stabilise the model in its base – this also meant that no pinning was required to fit the bionik leg.

Nazrot's gun is based on a Space Marine bolter (captured in an earlier encounter) to which has been added a lasgun and a short piece of brass tube that was sawn to the right length and the ends filed smooth.



For Rotnob's gun, two plastic bolters have been filed on one side and superglued together. The ends of mega-gun barrels have been added and a cut-down plastic Chaos autocannon superglued on top.



This awesome weapon is Skarfang's kustom speshul extra-long-range plasma gun (at least when it works!). The gun's been made from a pair of plasma guns taken from an Ork War Buggy. The front of one has been glued to the back of the other to create the extra length. The sight is made from brass tubing, sawn to length and filed smooth at the ends - the straps that hold the sight in place are simply two thin strips of paper wrapped around the tubing.

Skarfang has got a Gretchin servant to hold up the far end of the gun. Being so close to the shooty end of this weapon, the Gretchin looks understandably worried.



Snotwort's gun is based on a metal multi-melta. A plastic plasma gun has been filed flat on one side and added to the outside of the multi-melta. The snazzy bitz have been chopped off plastic Chaos weapons. Just in case this awesome weapon doesn't give Snotwort enough firepower, he's got an extra plastic bolter attached to his belt!

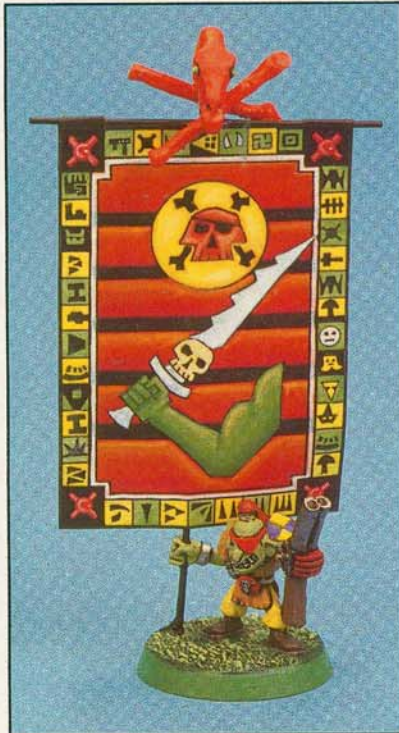

One of Badrukk's Gretchin retainers carries his boss-pole into battle. This impressive banner boasts the size of Badrukk's Freebooter mob, the noisiness of its guns and offers its services against all-comers: Humies, Squats, Space Marines and Eldar - they're all welcome enemies. The central images on the banner are the red-skulled Jolly Ork on a yellow background that appears in all the Gitz' banners (except for Badgor's, of course) and an arm holding a white saw-toothed sword, representing Badrukk's own chainsword.

Like all the other banners, this one was first drawn out in pencil and then painted. It was fixed to a T-shaped piece of stiff wire which was fitted into a hole that had been drilled through the Gretchin's hand. The version of the Jolly Ork Freebooter symbol on top of the banner pole was made using the skull of a plastic Skeletal Horse with a pair of leg bones.

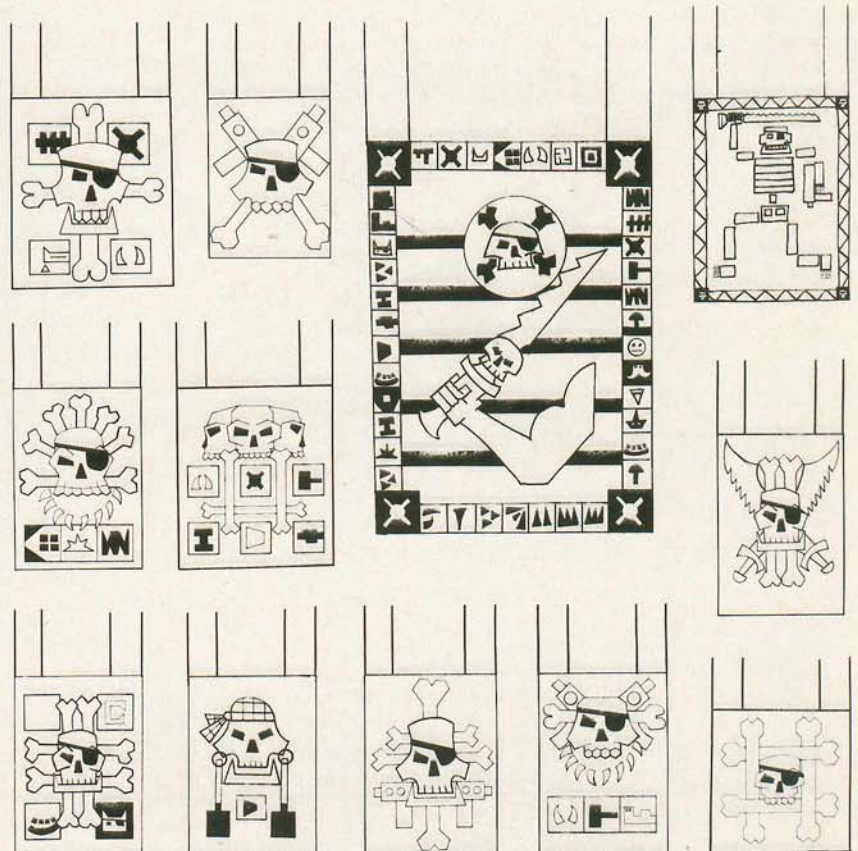

You can photocopy and paint these banners for use with your own Ork Freebooterz.



KUSTOM WEAPONS

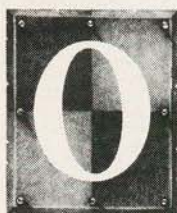

Orks make use of all kinds of weapons including types also used by Imperial forces and the Eldar. This means that Orks have their own designs of Boltguns, Plasma weapons, Flamers, Missile Launchers, and so forth. Although Orks understand and exploit laser technology, they don't really care very much for Lasguns and Laspistols, preferring

bulkier and noisier weapons such as Bolters.

The Ork Army Lists (from White Dwarf 123) define exactly which weapons the various Clans of Ork Boyz and Nobz can have. Ork weapons are sometimes built by human slaves, but they are more likely to be manufactured by a Mekboy. Naturally this means that the shape, size and performance of a weapon will vary depending on which Mekboy made it and what was going on in his head at the time. Generally speaking, Ork weapons perform pretty much like human or Eldar equivalents - except they are prone to malfunction occasionally (as described in the Malfunction Rules in White Dwarf 133).

Sometimes (quite often in fact) a Mekboy will have a good idea which he happily imagines will vastly improve an

ordinary weapon, giving it extra range, extra power, an unusual spread of fire, or several shots at a time instead of just one. The enthused Mekboy will disappear into his workshop for hours or even several days, only re-emerging when he has completed his magnificent new invention. Occasionally this process results in a Mekboy producing an incredibly effective weapon which out-performs any ordinary gun. More often he will manage to introduce a minor modification which slightly improves some aspect of the weapon's performance but at the detriment of another: for example it might fire faster than normal but have a shorter range, or it might have a longer range but a slower rate of fire. Occasionally his invention will fail on all counts, being substantially worse than the original version it was based on.

Regardless of the actual effectiveness of the weapon, a Mekboy will be so enthusiastic about his new creation that he is quite unable to admit to any shortcomings it might have. A Mekboy is only too pleased to sell his weapon once it is finished. These special Kustom Weapons, as they are called, are much sought after by Ork Nobz who are always eager to obtain the best and newest examples of Orky workmanship. Even though these Kustom Weapons may malfunction at any moment, especially in the heat of battle, many Orks consider it well worth taking the risk. After all, if the weapon functions all right on the day it may do incredible damage to the great satisfaction of the owner. Of course, now and again a weapon of awesome power is produced, and its owner is sufficiently lucky to exploit its potential to the full, causing considerable devastation to the enemy's forces and winning the day for the Orks. Such an event, whilst largely fortuitous, vastly increases the demand amongst other Ork Nobz for Kustom Weapons.

There are two different types of Kustom Weapons: Kombi Weapons and Kustom Specials. Kombi Weapons consist of several weapons combined together in a cunning fashion. Kustom Specials, on the other hand, are standard Orky weapons, tribute gear or captured weapons which have been tinkered with by Meks to 'improve' them (hopefully). Kombi Weapons are sometimes themselves modified or made up of modified components.

The Army Lists indicate which particular Orks may be equipped with a Kustom Weapon. In some cases the Army List specifies which types of Kustom Weapon may be chosen, but in most instances the weapon is randomly generated. The Kustom Weapons Charts are used to randomly determine the type of Kustom Weapon, whether it is a Kombi Weapon or Kustom Special and what sort of weapon it is based on. These charts are given in the Army Lists along with the other random generation charts, but they are repeated here so that you can refer to them as you read about the different modifications and their effects.

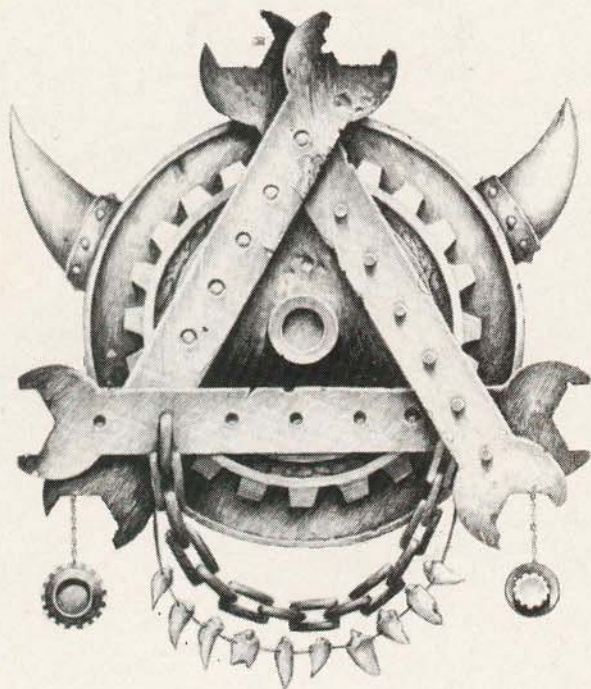

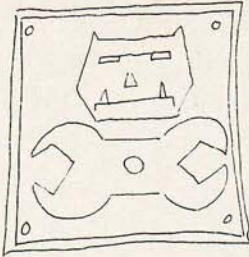

BIG BOSS MEK MEK GOG
 PLANS FOR DA KUSTOM
 SPESHULLS WOTZ
 MADE IM LOADS OV
 TEEF

BIG BANG SPEAKA

SNAZZY
 BOLTA

BOSS ED SNAZZY
 SHOOTY END

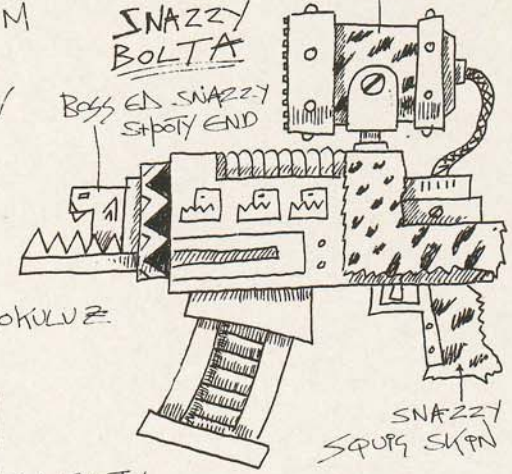

SNAZZY
 SPOUG SKIN

BIG MENDY BITZ
 KUVA DUFF
 OOMAN JOB

MENDY
 BIT

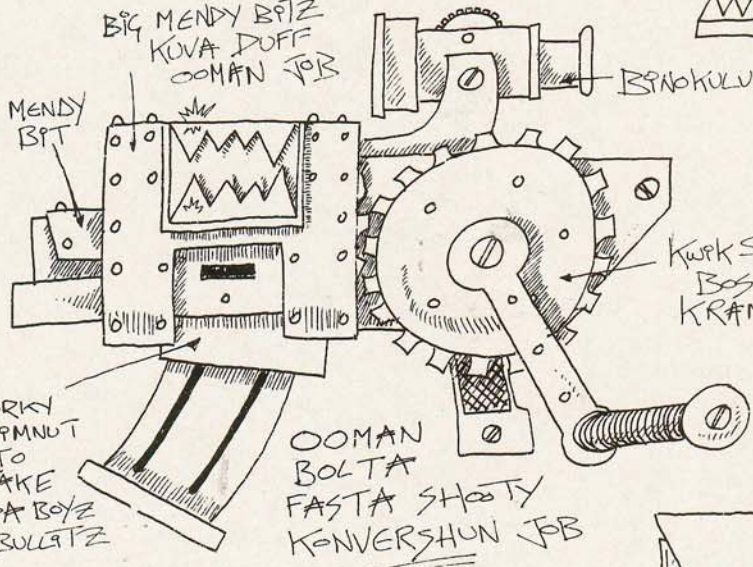

BRINKULVZ

KWIK SHOOTY
 BOSS
 KRANK

ORKY
 QPMNUT
 TO
 TAKE
 DA BOYZ
 BULLITZ

OOMAN
 BOLTA
 FASTA SHOOTY
 KONVERSHUN JOB

STEEM
 TOOB

SPARKY
 BOX

KOOLY
 TANK

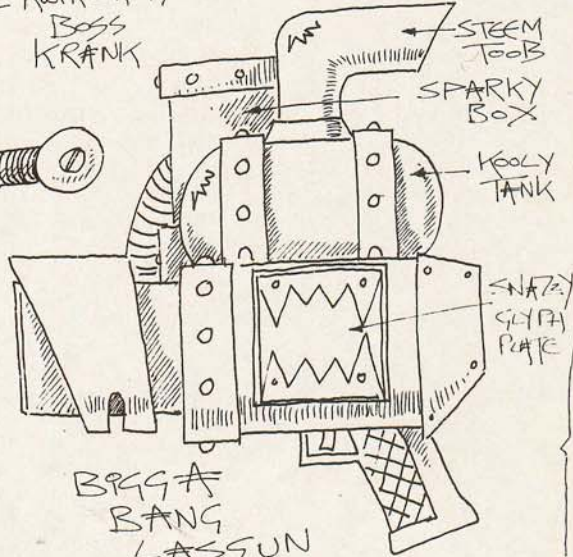

SNAZZY
 GLYPH
 PLATE

BIGGA
 BANG
 LASSUN

CAS GUN SHOOTY BIT

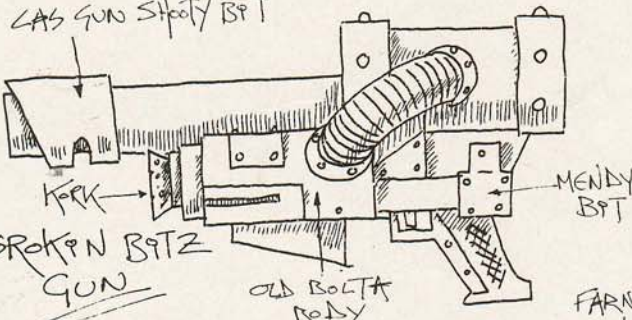

KRKK

MENDY
 BIT

BROKEN BITZ
 GUN

OLD BOLTA
 BODY

FARNESS SUBBINS SWITCH

TELLY SHOTFE

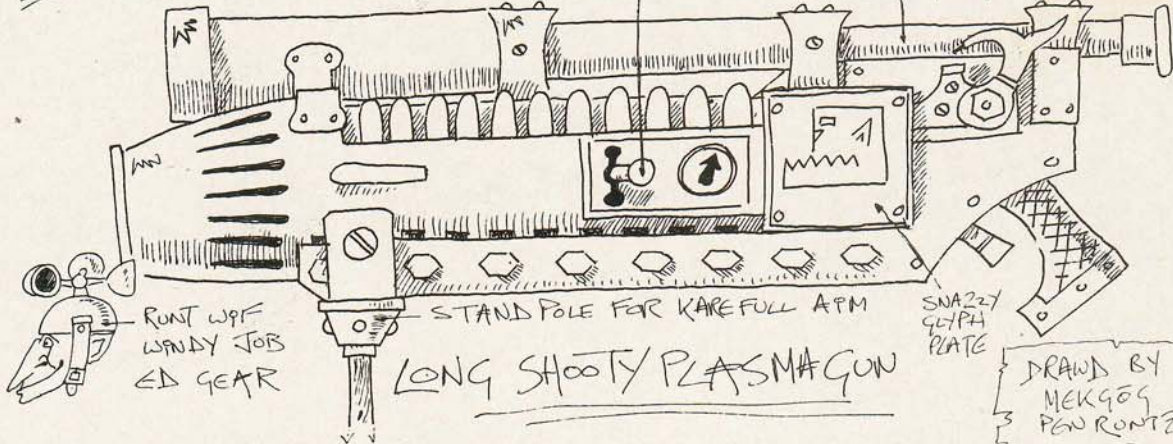

RUNT WIF
 WANDY JOB
 ED GEAR

STAND POLE FOR KAREFULL APM

LONG SHOOTY PLASMA GUN

SNAZZY
 GLYPH
 PLATE

DRAWN BY
 MEK GOG
 PGN RONTZ

Mek concept drawings for Kustom Weapons

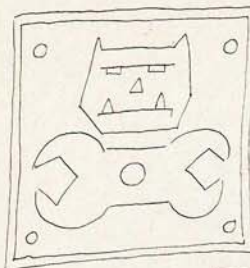

BPG MEK MEK GOG FRANE
FOR DA BPG SHOOTY SPESHULS
WID LOTSOV BARRULS FOR
MAKING DA BPG WARRKREH

BULLET BOX
FOR STUBBA
ON SIDE

SPINNING WIDGET
STABILIZER

BOLTA
LASSUN
STUBBA
STUBBA

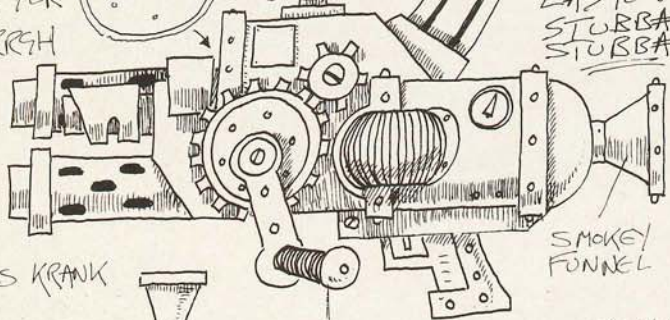

SMOKEY
FUNNEL

AUTO KANNON
BOLTA
BOLTA

BPG BULLET
BOX

BOSS KRANK

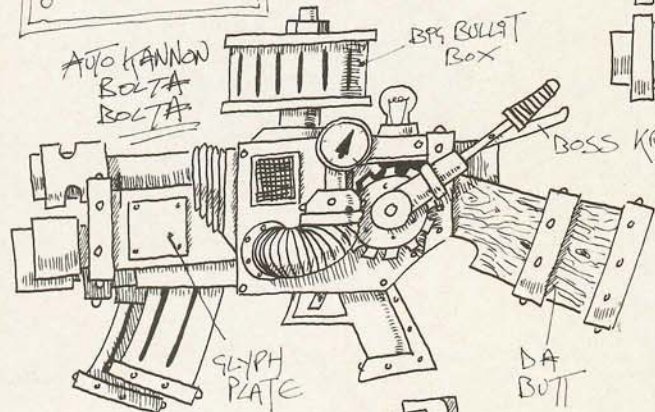

SLAPH
PLATE

DA
BUTT

KWIK SHOOTY BOSS KRANK

PRESHUR TAP

BLUNDERBUS
BOLTA
BOLTA

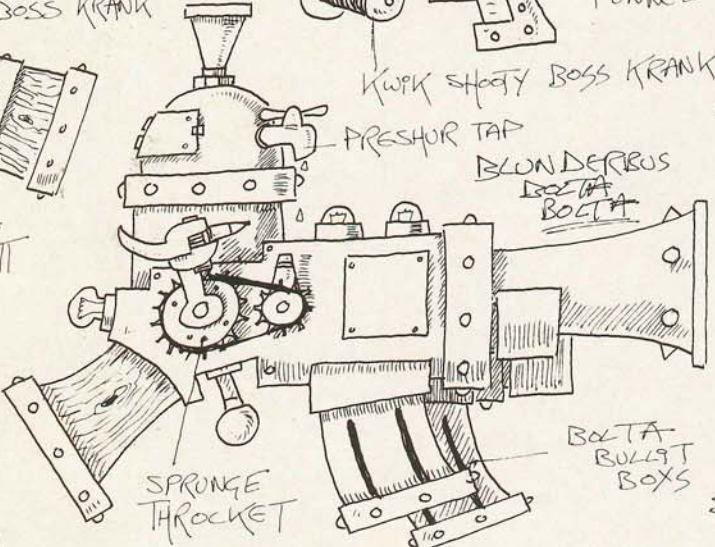

SPRUNGE
THROCKET

BOLTA
BULLET
BOXS

MISSILE LAUNCHER
LASSUN
FLAMM

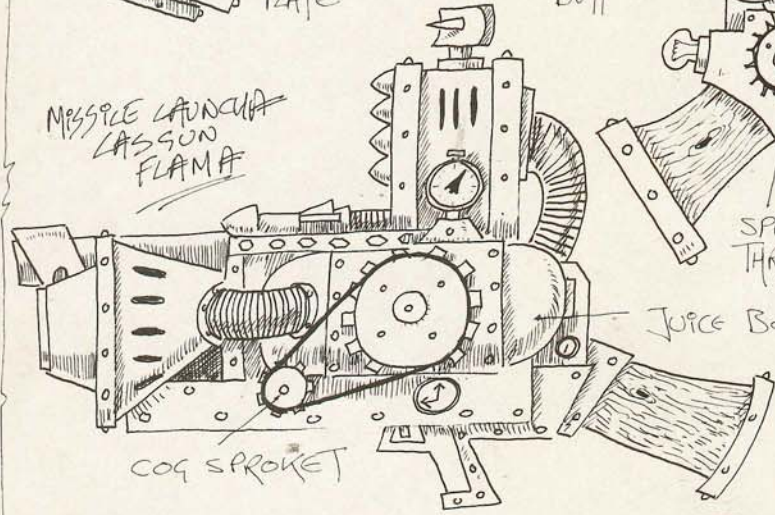

COG SPROCKET

JUICE BOX

BPG
BULLET
BOX

BOSS BOLT

SHOTGUN
STUBBA
BOLTA

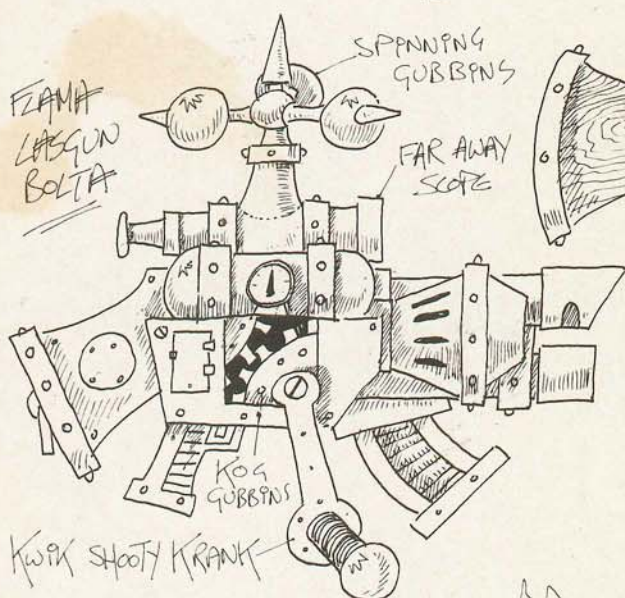

FLAMM
LASSUN
BOLTA

SPINNING
GUBBINS

FAR AWAY
SCOPE

KOG
GUBBINS

KWIK SHOOTY KRANK

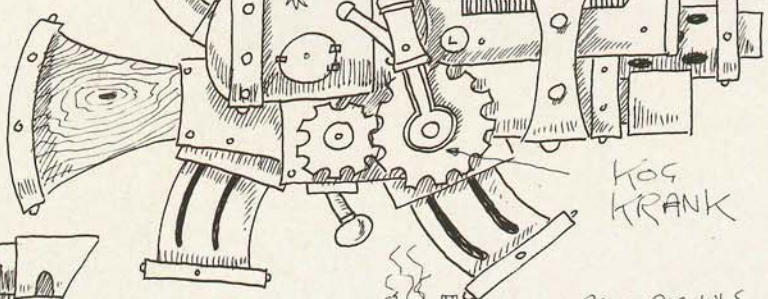

KOG
KRANK

EXTRA SPESHULS
WTH BPG KOOLY
BOYLERS
FOR LOADSA
BARRULS

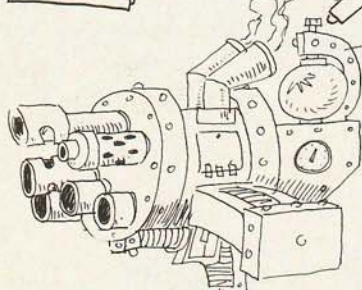

DRAWN BY
MEK GOG
PEN RUNTZE

Mek concept drawings for Kombi Weapons

KUSTOM WEAPON CHART

Kustom Weapons are specially modified by the ever inventive Mekboyz. Roll a D6 to establish the basic type.

D6	Type
1-2	Kombi Weapon
3-6	Kustom Special

KOMBI WEAPON

Kombi Weapons combine several individual weapons in one huge super-weapon! Roll a D6 to determine how many individual weapon barrels the Kombi Weapon has.

D6	Number of Barrels
1-2	2 Barrels
3-4	3 Barrels
5-6	D4+1 Barrels

Once you have determined how many barrels the Kombi Weapon has roll a D100 for each barrel to determine its type.

D100	Barrel Type	D100	Barrel Type
01-10	Auto cannon	65	Las pistol
11-12	Auto gun	66-67	Lasgun
13	Auto pistol	68-70	Melta gun
14	Blunderbuss	71-81	Missile launcher
15-31	Bolt gun	82-84	Multi laser
32-35	Bolt pistol	85-88	Multi melta
36	Conversion beamer	89	Needle gun
37-38	Flamer	90	Needle pistol
39	Graviton gun	91-92	Plasma gun
40-42	Grenade launcher	93-94	Plasma pistol
43-44	Hand flamer	95	Shotgun
45-50	Heavy bolter	96	Shuriken catapult
51-54	Heavy plasma gun	97	Shuriken pistol
55-58	Heavy stub	98-99	Stub gun
59	Heavy webber	100	Web gun
60-64	Las cannon		

In some cases a Kombi Weapon may consist of several weapons which are themselves modified. On the D6 roll of a 6 a Kombi Weapon is made from Kustomised weapons - roll to determine the Kustom modification for each constituent weapon as for Kustom Specials. If the weapon is being generated for a Mekboy then the player may choose to Kustomise the Kombi-Weapon or not as he pleases.



KUSTOM SPECIALS

There are two kinds of Kustom Specials represented by two different charts. These are Standard Weapons and Heavy Weapons. If the weapon is generated for a Mekboy the player may choose to roll on either the Standard Weapon Chart or the Heavy Weapon Chart. If the weapon is generated for any other model then the player rolls a D6 to determine what sort of Kustom Weapon is generated.

D6	Chart
1-3	Standard Weapon
4-6	Heavy Weapons

STANDARD WEAPONS

Roll a D100 to determine what sort of weapon forms the basis of the Kustom Special.

D100	Weapon	D100	Weapon
01-10	Auto gun	76	Needle gun
11-16	Auto pistol	77	Needle pistol
17	Blunderbuss	78-84	Plasma gun
18-34	Bolt gun	85-92	Plasma pistol
35-49	Bolt pistol	93	Shotgun
50-58	Flamer	94	Sawn off shotgun
59	Graviton gun	95	Shuriken catapult
60-66	Hand flamer	96	Shuriken pistol
67-68	Lasgun	99	Stub gun
69-70	Las pistol	100	Web gun
71-75	Melta gun		

HEAVY WEAPONS

Roll a D100 to determine what sort of weapon forms the basis of the Kustom Special.

D100	Modified Heavy Weapons
1-18	Auto cannon
19	Conversion beamer
20	Distortion cannon
21-23	Grenade launcher
24-40	Heavy bolter
41-55	Heavy plasma gun
56-60	Heavy stub
61	Heavy webber
62-70	Las cannon
71-85	Missile launcher
86-90	Multi laser
91-100	Multi melta

KUSTOM SPECIALS

A Kustom Special has been modified by a Mekboy to 'improve' its performance in some way. All sorts of weapons are modified by the Mekboys: standard Orkish designs, tribute weaponry and captured enemy weaponry. Modifications take the form of a wide range of Mekaniak tinkering; anything from 'mending' broken weapons, to complete rebuilding using parts stripped from several others.

A Kustom Special has at least one modified characteristic and can have up to three. Roll a D6 to determine the number of modified characteristics on Da Kustomizin Chart, below.

D6	Number of rolls on Da Kustomizin Chart
1	1
2-3	2
4-5	3
6	D6

Roll on the Kustomizin Chart to determine the results of the Mekboy's efforts. First roll a D6 to discover which aspect of the weapon has been changed (this may be its range, 'to hit' modifier, strength value, damage, rate of fire, or its area effect). Then roll a further D6 to see what effect the Mekboy's endeavours have had.

PAUL BONNER

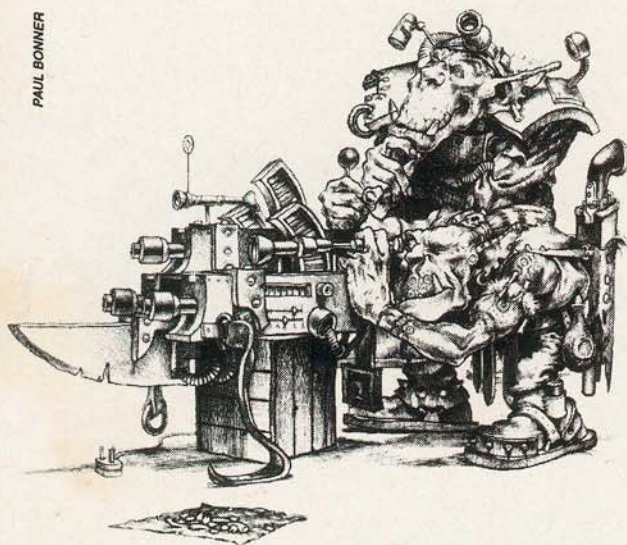

Range The maximum range of the weapon is reduced or increased by the amount shown. The short range is reduced or increased by half this amount - eg a Bolter with short range of 12" and long range of 24" will, on the roll of a 4, have a long range of 28" and short range of 14". A weapon's range cannot be reduced to less than 1".

To Hit The score indicated is added to the usual To Hit modifier. For example, a Bolter normally has +1 at short range and no modifier at long range; on the score of a 3 the modifier becomes +2 at short range and +1 at long range.

Strength The score indicated is added to the weapon's strength value. Strengths cannot be reduced below 1 or increased to more than 10 as a result of a modification.

Damage The weapon's usual damage value is ignored and the value indicated is substituted instead. Although the range of results is quite high the actual values are random (eg the best result of D12 gives a range of from 1 to 12 points of damage). This is quite fitting for a Kustom Weapon!

Rate of Fire If the weapon is usually Slow, or has Following Fire, both of these characteristics are ignored. The weapon's rate of fire is now as indicated on the chart. Slow weapons cannot be moved and fired in the same turn. A result of 2 or 3 shots means the model may fire twice or three times in the shooting phase - all targets must lie within the model's arc of fire without moving model inbetween shots. A result of FF indicates that the weapon now has Following Fire. A result of normal means just that - the weapon may move and fire like a normal weapon but derives no additional benefit.

Area Effect Regardless of whether the weapon normally has an area effect or not it now has an area effect with a template of the radius indicated on the chart.

DA KUSTOMIZIN CHART

D6 First Roll		D6 Second Roll					
		1	2	3	4	5	6
1	Range	-12"	-8"	-4"	+4"	+8"	+12"
2	To Hit	-2	-1	+1	+1	+2	+3
3	Strength	-3	-2	-1	+1	+2	+3
4	Damage	1	D3	D4	D6	D10	D12
5	Rate of Fire	Slow	Slow	Normal	2 Shots	3 Shots	FF
6	Area Effect	None	1" Radius	1" Radius	1" Radius	2" Radius	3" Radius

EAVY METAL

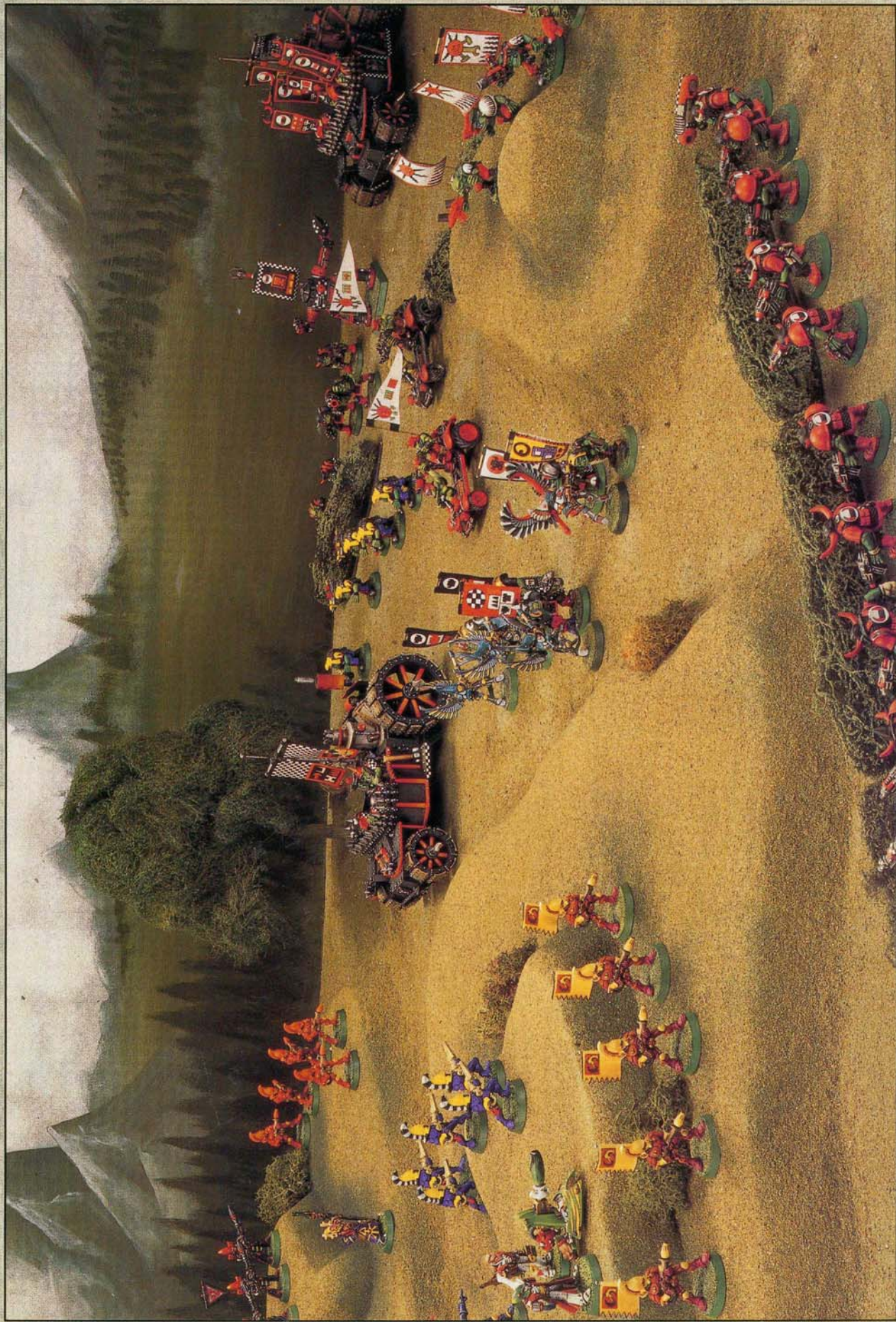

Ghazghkull's Goff Warband (as seen in White Dwarf 134) in action against Eldar Aspect Warriors.

SNAZZY BITZ

A player may decide that rather than roll on the Kustomizin Chart he will roll on the Snazzy Bitz Chart instead. He may decide to roll none, one, any number or all of his modification of this chart if he wishes - it is totally up to the player.

Snazzy Bitz rarely have any actually battlefield effect, but have considerable prestige value (especially among Evil Sunz who have 'More teef dan dey knows wot ter do wiv').

SIDE EFFECTS OF KUSTOMIZIN'

A Mekboys tinkering often result in altogether unexpected side effects which usually only come to light in the heat of battle, when the Kustom weapon is being put to the test in combat conditions. The first time the weapon is fired roll a D6 to determine how many side effects have been unknowingly incorporated into its design.

D6	Number of Side Effects
1-3	None
4	1
5	2
6	D6

Determine what these side effects are on the Side Effects Chart, over the page.

SNAZZY BITZ CHART - Roll a D10

- 1 The barrel is decorated with the gaping mouth of a ferocious beast (wiv real teef!)
- 2 The weapon is plated in gold or another exotic precious metal.
- 3 The weapon is fitted with loudspeakers which amplifies the blast whenever the Ork pulls the trigger
- 4 The weapon is fitted with an enormous blade or axe - this enables the Ork to attack in hand-to-hand combat with a +1 strength.
- 5 The weapon is decorated with sculpted Orkish glyphs and runes.
- 6 The weapon is fitted with a flared barrel to increase the flash and noise every time it fires. Unfortunately this reduces the maximum range by 6'.
- 7 A sheet steel shield has been fitted to the weapon. This adds +1 to the Ork's saving throw if he is shot at from the front.
- 8 The weapon has an infra red searchlight fitted to it. The user can see targets through smoke, mist, at night and through all kinds of gas clouds except for Blind.
- 9 The weapon has a spotted squigskin handle and carrying case engraved with the owner's Clan Badge and personal identifying glyphs and badge - very snazzy!
- 10 The weapon has a built-in device which projects a brightly coloured beam or which makes shells glow brightly when they are fired. This attracts attention to the owner and also makes it easier for him to hit as he can see where his shots are going - add +1 to the firer's To Hit score.

PAUL BONNER

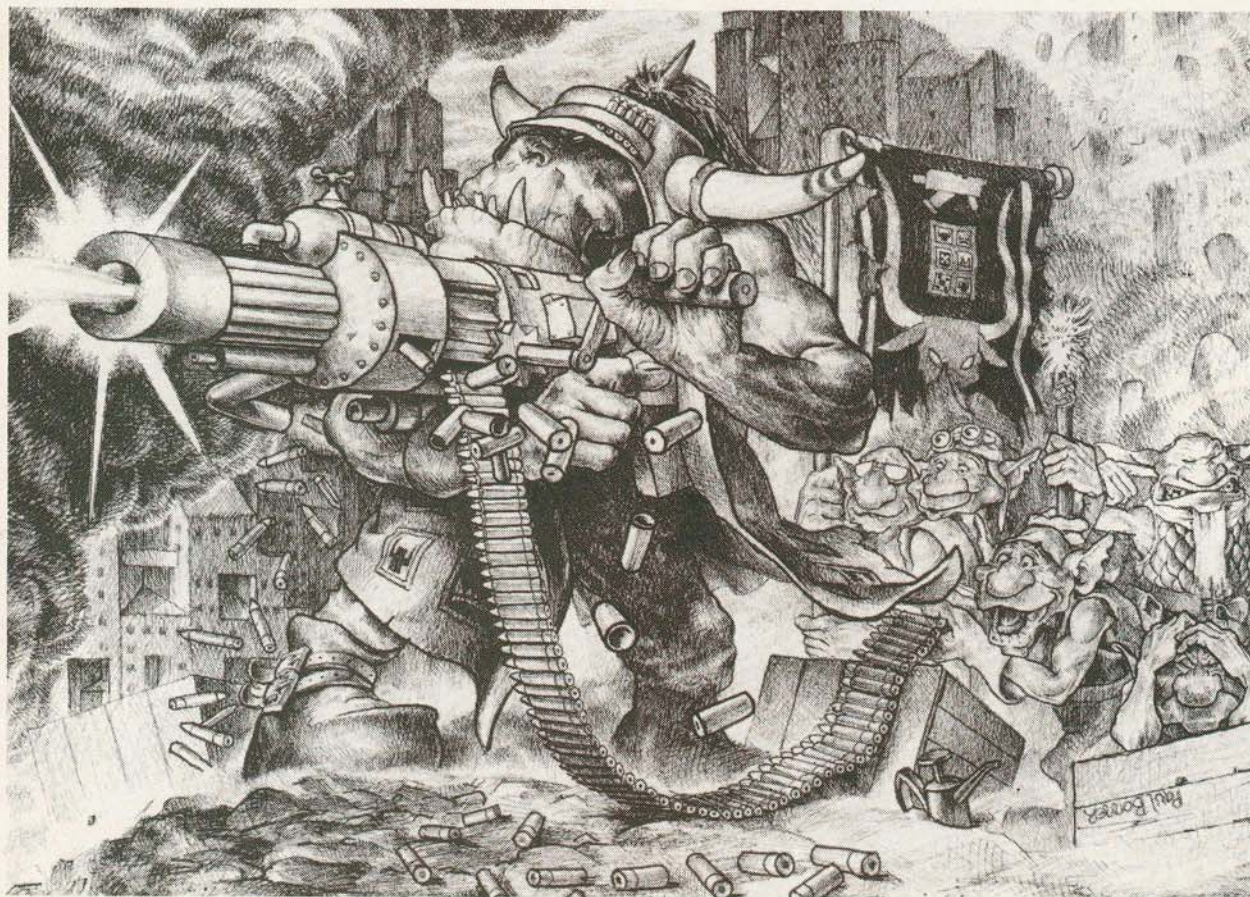

GAMES WORKSHOP™

SHEFFIELD

GRAND RE-OPENING

SAT 23rd MARCH

AT OUR NEW ADDRESS:
16 FITZWILLIAM GATE
 TEL: (0742) 750114

Normal Hours:

9.30am-5.30pm Mon-Wed, Fri & Sat

9.30am-8pm Thur

Gaming Club: 11am-5pm Sun & Thurs Eve



BUY ANY 2 RED DOT ITEMS AND GET 1 YELLOW DOT ITEM FREE!

EG: BUY WARHAMMER 40,000 AND BLOOD BOWL AND GET WAAARGH THE ORKS FREE!

BUY ANY 2 BLISTER PACKS AT £2.99 OR OVER AND GET ONE ADDITIONAL £2.99 BLISTER PACK FREE!

BUY ANY 3 EPIC MINIATURE BOXES AND SAVE £4

BUY ANY 3 PAINT SETS AND SAVE £3

LOTS OF GAMES & ACCESSORIES FOR £2.50 OR LESS

OFFERS LAST ALL DAY (WHILE STOCKS LAST)

PLEASE NOTE: YOU CANNOT USE THE VOUCHERS WITH ANY OF THE ABOVE OFFERS



ONLY ONE VOUCHER PER PRODUCT REDEEMABLE AT GAMES WORKSHOP SHEFFIELD SAT 23rd MARCH

10 % OFF

ANY GAMES WORKSHOP OR CITADEL PRODUCT

NOT TO BE USED WITH ANY OTHER OFFER

ONLY ONE VOUCHER PER PRODUCT REDEEMABLE AT GAMES WORKSHOP SHEFFIELD SAT 23rd MARCH

10 % OFF

ANY GAMES WORKSHOP OR CITADEL PRODUCT

NOT TO BE USED WITH ANY OTHER OFFER

ONLY ONE VOUCHER PER PRODUCT REDEEMABLE AT GAMES WORKSHOP SHEFFIELD SAT 23rd MARCH

25 % OFF

ANY GAMES WORKSHOP OR CITADEL PRODUCT

NOT TO BE USED WITH ANY OTHER OFFER

ONLY ONE VOUCHER PER PRODUCT REDEEMABLE AT GAMES WORKSHOP SHEFFIELD SAT 23rd MARCH

25 % OFF

ANY GAMES WORKSHOP OR CITADEL PRODUCT

NOT TO BE USED WITH ANY OTHER OFFER



SPECIAL GRAND OPENING DISCOUNT PRICES!

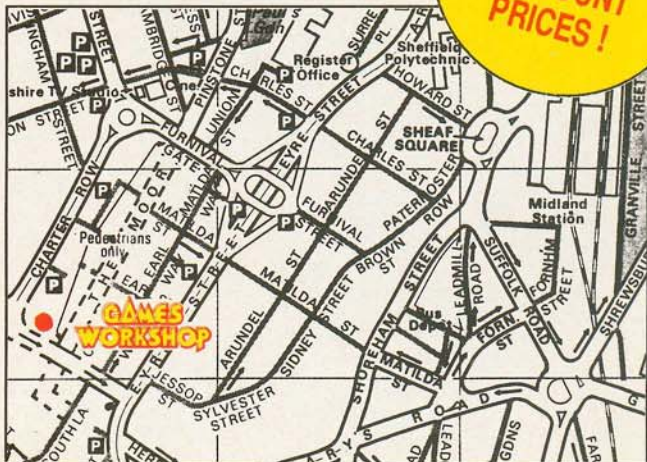

DOORS OPEN 9AM

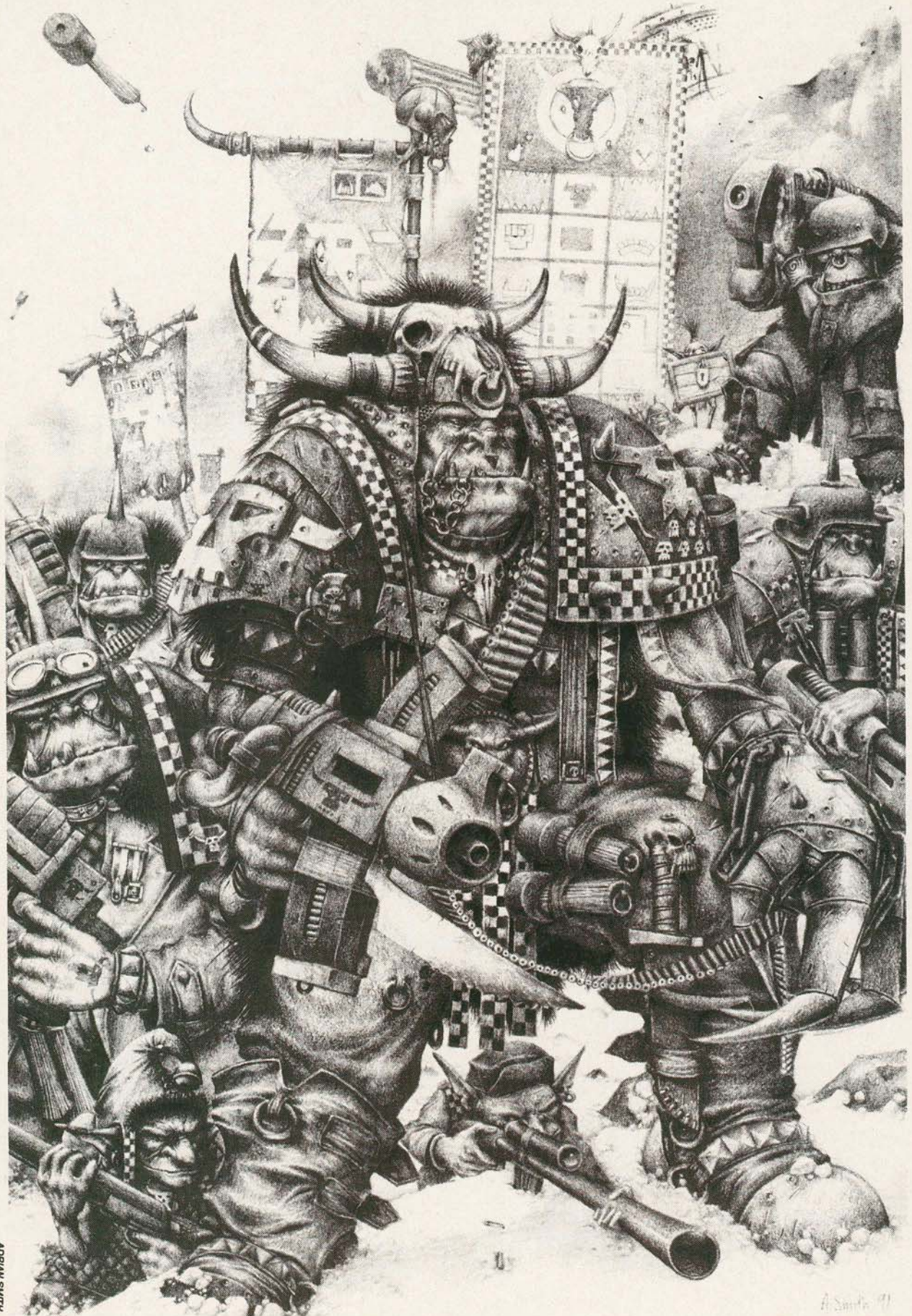

ADRIAN SMITH

A. Smith '91

DA SIDE EFFECTS CHART - Roll a D10

- 1 **Powerful Recoil.** Massive recoil knocks the Ork off his feet. If the Ork can roll equal to or less than his Strength on a D6 he may immediately get up again. Otherwise he must get up in his following movement phase and he may not then move or shoot that turn.
- 2 **Jams.** The weapon jams constantly causing grief and frustration to its owner. On a To Hit dice roll of a 1 the weapon jams and the shot is not fired. Roll a D6 to determine the effect.
- 1 In his attempts to unjam the weapon the Ork shoots himself! Resolve the hit against the Ork in the normal way. If the Ork survives the weapon is now free for normal use.
- 2 The Ork's attempts to unjam the weapon by bashing it hard against a rock only succeed in bending it into a right angle. The weapon is now useless.
- 3 The Ork fails to unjam the weapon. The weapon can be abandoned or the Ork can try to unjam it in his next turn by rolling on this chart again. Should the Ork decide to continue to try and unjam the weapon he may neither move nor shoot in the turn.
- 4-6 The Ork clears the fouled weapon so that it is ready for normal use next turn.
- 3 **Overheats.** The weapon is prone to overheat with continuous use - the more it is fired the hotter and hotter it gets. The first time the weapon is fired there is no risk. thereafter any To Hit roll of a 1 means that the weapon has overheated and does not fire. Roll a D6 to determine the effect.
- 1 The weapon explodes causing a strength 5 hit on the Ork. Even if the Ork survives the weapon is so badly damaged that it is useless.
- 2 The weapon shatters with a flash and a great deal of oily smoke. The owner is left scorched, soot-smudged, with his clothes reduced to tatters and an embarrassed look on his face. Other than feeling crest-fallen and surprised the Ork is not harmed - the weapon is reduced to a useless lump of metal.
- 3 Some internal components melt and dribble out of the barrel rendering the weapon completely useless.
- 4-6 The weapon fails to fire as some metal components have expanded and jammed the mechanism. However, the weapon can be fired next turn as it will have cooled sufficiently by then to allow the parts to move freely once more.
- 5 **Cloud of Smoke.** A huge cloud of smoke is released every time the weapon is fired. This covers an area 2" in radius around the model. This completely obscures visibility until the beginning of the Ork player's next turn. No model may see into or out of the smoky cloud - even if equipped with special sights or infra-vision. Models wishing to move or shoot out of the cloud must move/shoot in a randomly determined direction.
- 6 **Armour Buster!** The weapon's armour penetrating capabilities are unexpectedly enhanced beyond all reason! The Mekboy is naturally very proud of his invention - although somewhat unsure about how he achieved such spectacular results. Any model hit by the weapon suffers an extra -4 modifier on their armour saving throw. If a vehicle is hit by the weapon an extra D6 is added to the penetration score (ie a Boltgun's penetration is normally 4+D6, but now it is 4+2D6).
- 7 **Incredible Noise.** When the weapon is fired it makes an altogether unexpected and extremely alarming noise. The first time the Ork fires the weapon the surprise is so great that he automatically spoils his aim and misses. Thereafter he gets accustomed to the huge boom or sudden volcanic gurgling and takes considerable pride in his weapon's unusual attribute.
- 8-10 **Wild Shot.** The Mekboy's efforts to improve the weapon have seriously affected barrel alignment and balance. The weapon is extremely difficult to aim properly and sometimes it will launch a shot that is way off target. Every time the weapon is fired first roll a D6. On the score of 1-5 the shot is fired as normal. On the score of a 6 the shot has veered off target in some unpredictable manner. Roll a D6 to establish where the shot lands.
- | D6 | Wild Shot |
|----|--|
| 1 | D6" to right of intended target |
| 2 | D6" to left of intended target |
| 3 | D6" behind intended target |
| 4 | D6" in front of intended target |
| 5 | D6" in front of the weapon itself |
| 6 | 3D6" in front of the weapon (even if this takes the shot beyond the normal range of the weapon). |



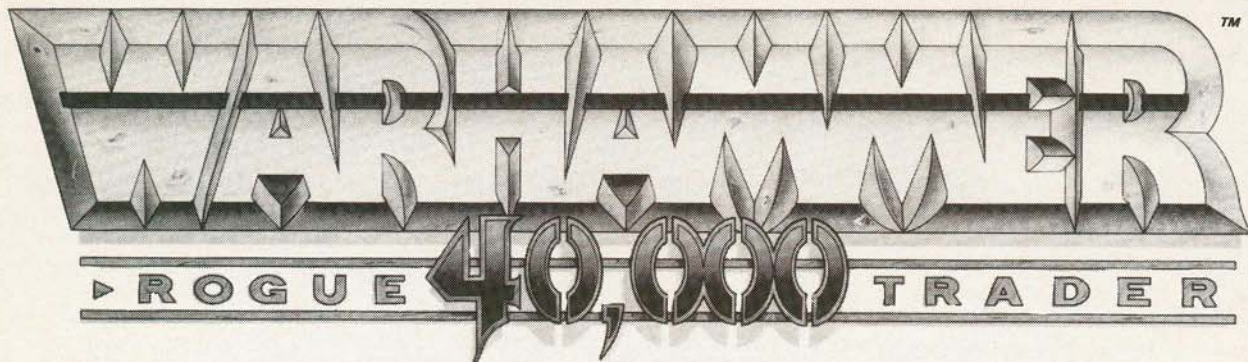

VEHICLE POINTS VALUES

BY NIGEL STILLMAN

New vehicle rules for Warhammer 40,000 are now appearing in instalments in *White Dwarf*. They introduce a new way of dealing with vehicles in the game and we hope they'll prove more interesting than the rules they supersede. However, the new rules pose the problem of revising the points values of vehicles. Here we suggest some revised values to reflect the relative strengths of the vehicles in battle.

Previously, the points value of a vehicle was calculated according to a formula. Each characteristic of the vehicle was given a value and the total was added up, together with the value of the armament and any additional equipment. The new rules require us to take a radically different approach for the revised vehicles.

There are several significant changes in the new rules which affect points values. These include: the fact that vehicles no longer have power fields as part of their standard equipment; the varying armour rating for different parts of the vehicle, shown on the data sheet; the reduced chance of hitting a small fast vehicle as compared to larger 'tank' style vehicles; and the greater vulnerability of open vehicles as opposed to enclosed vehicles.

Another important consideration is that vehicles are large targets compared to infantry models and consequently always attract more enemy fire. This affects the relative value of the vehicle's armament compared to the equivalent weapon used by a foot soldier. A heavy weapon mounted on a vehicle actually becomes less valuable and less cost effective than a heavy weapon used by an infantry model for the following reasons:

1. The vehicle presents a larger target than a foot soldier.
2. Although the vehicle is faster, it cannot use cover as effectively as a foot soldier.
3. If a squad of infantry are armed with several heavy weapons, it will take time to knock out each individual weapon operator, but a vehicle armed with several heavy weapons can be knocked out in one go by a single lucky hit.
4. A vehicle transporting a unit of infantry actually makes the infantry more vulnerable while in close range of the enemy, since the vehicle is a larger target and easier to hit than the individual soldiers it is carrying.

The advantages that a vehicle gives to its armament or payload of troops are mobility and, if well-armoured, a certain amount of survivability.

These advantages can only be gained when the vehicle is used skilfully in the appropriate tactical situation. In other words, the vehicle could be worth all its points, and more, to a good player at the right time, in the right situation and against the right opposition. In other circumstances, if used ineptly, the vehicle may seem to be worth a lot less than its stated points value.

The points value, then, can only ever be an estimate of the vehicle's potential value to the army. If you use it correctly you get its full value. If not, it's likely that your own tactics or your opponent's skill and luck have cancelled out your points investment.

One thing is clear: the points value of a vehicle can no longer be calculated by allocating arbitrary values for all the characteristics and armament and then adding them up. That is just too simple and unrepresentative.



After a lot of thought, discussion, some playtesting and a questionnaire which we distributed to all the Games Workshop stores to collect players' points of view, we have established a few basic principles for estimating points values. These include:

1. The points value of each vehicle is estimated relative to other vehicles and infantry units, taking into account its strengths and weaknesses in different circumstances, against different kinds of opposition. Fighting battles with the vehicles is the best way to judge these relative values.
2. The values of Ork vehicles take into account the fact that they are prone to random breakdowns occurring as a result of Malfunction Cards.
3. A vehicle with the principal function of transporting a unit of infantry into the battle zone is worth less in points than the unit it transports. Indeed, such vehicles can be considered as merely 'equipment' owned by the unit.

For example, a squad of Imperial Guard is the result of long years of training and battle experience, often recruited from the cream of the gang fighters on a hive world. They ride to battle in a Rhino which was constructed from recycled scrap metal in a matter of minutes on the production line of a workshop on the same hive world. So which is more valuable to the Imperium? The squad probably wrote-off a dozen Rhinos while training!

4. A player who opts to use vehicles is making an investment of points in mobility and blitzkrieg tactics. A player who opts for predominantly infantry is investing in firepower and static defence (or subtle infiltration in close terrain). Infantry are hard to hit, especially if in cover, so the latter player gains the full value of his heavy weapons. Vehicles move in close to the enemy, reducing the range and making targets of themselves. This means that the player using them has exchanged some of the value of his firepower for mobility. As we've explained, a heavy weapon is reduced in value when mounted on a vehicle – infantry heavy weapons, on the other hand, become more useful when there are enemy vehicles to shoot at.

This reasoning has led us to the revised list of vehicle points values given here. We think these more realistically reflect the relative values of the vehicles under the new vehicle rules. Some lightly-armoured, open-topped, small and vulnerable vehicles have been drastically reduced in points cost. This makes them more cost effective to use in the correct tactical fashion!

Transport vehicles in particular benefit from these revised values, making it possible for each unit in an army to have one – as, indeed, is the practice in several forces in the Warhammer 40,000 universe.

Haven't you ever wondered how troops covered thousands of miles to get to battle? A common tactic among Imperial forces is to dismount from their Rhinos or Land Raiders on coming into heavy weapon range of the enemy and then for each squad to follow behind its transport vehicle, using it as a kind of shield while remaining invulnerable to hits on the vehicle and unseen from the enemy positions until they are overrun. Only by revising the points values can correct tactics like these be recreated in your games.

These values only represent a mean or average cost which we'll apply when we design new army lists. However, some future lists may use slightly different values to reflect the troops concerned. For example, an Ork Warboss Retinue gets its Battlewagon free, but other Ork units pay for them. The values given here are not written in stone, by any means – variable values will be used as we see fit!

All these adjustments will be given in the army lists and any points values given in army lists (such as the Ork lists we're about to release in 'Ere We Go) always take precedence over the figures given here.

NEW VEHICLE POINTS VALUES

These revised points values have been designed for use with the new vehicle rules.

Vehicle	PV
Bike	15
Bike and Sidecar	25
Eldar Jet Bike	25
Eldar War Walker	150
Harlequin Jet Bike	35
Imperial Banblade	500
Imperial Jet Bike	20
Imperial Land Raider	250
Imperial Land Speeder	100
Imperial Predator	200
Imperial Rhino	25
Imperial Sabre	75
Imperial Sentinel	50
Imperial Spartan	250
Imperial Vindicator	200
Imperial Whirlwind	150
Ork Battlewagon	50
Ork Blitzkanon	100
Ork Gobsmasha	200
Ork War Buggy	75
Ork Warbike	50
Ork Wartrak	50
Ork Wartrak Skorcher	90
Squat Trike	30

This is not necessarily the last word on vehicle points values, as these figures are still experimental. Let us know what you think of the new values. If, after playing a battle or two with them, you think something should be more or less expensive, write in with your comments – and tell us why you think the vehicle is over or under priced.

Write with any comments to:

Rick Priestley
Warhammer 40,000 Vehicles
Games Workshop Design Studio
Enfield Chambers, 14-16 Low Pavement
Nottingham, NG1 7DL

Due to the volume of mail we're likely to get about vehicle points values, we won't be able to reply to you individually, but rest assured that we read every letter with great interest.

IMPERIAL JET BIKE

DATA RECORD: IMP7

There are several versions of the Imperial Jet Bike, but all have similar performance and are represented in the game by means of a single data sheet. The targeting diagram below is used for all Imperial Jet Bikes regardless of their specific design. The values below are for the jet bike when it is hovering just above the ground; as with the Eldar Jet Bike, the Imperial type can also fly – new rules are being prepared for flying vehicles in Warhammer 40,000, and these will be published in a future White Dwarf. Meanwhile the flying rules from the current WH40K rulebook may be used with the following changes: the speed of the Imperial Jet Bike is reduced to 60" and any models flying off the table take no further part in the game.

Type	Jet Bike
Fast Speed	32
Combat Speed	16
Slow Speed	10
Crew	1 Rider

Weapons Twin Bolters with a 45° field of fire to the front. These are synchronised to fire together. Roll once to hit – either both hit or both miss.

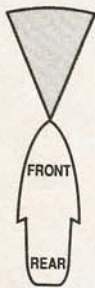

TWIN BOLTERS 45°

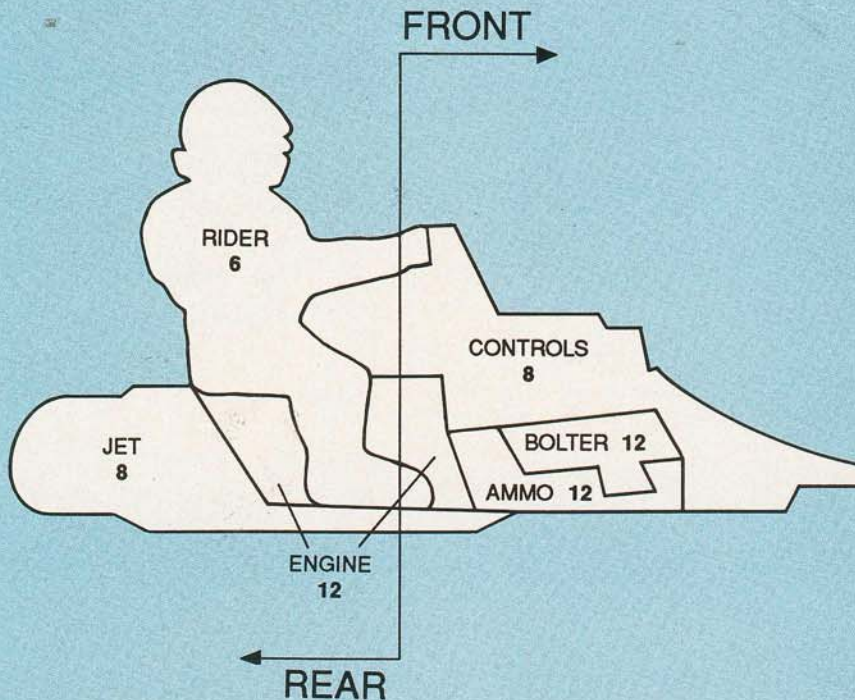

2 x SCALE

ELDAR JET BIKE

DATA RECORD: ELD1

The Eldar Jet Bike is a fast and highly manoeuvrable weapon of war. It is armed with twin forward-firing shuriken catapults, synchronised to fire simultaneously. The movement details below refer to its movement as it skims along the ground, suspended a metre or so above the surface by its grav-motor. The jet bike can also fly – new rules are being prepared for flying vehicles in Warhammer 40,000, and these will be published in a future White Dwarf. Meanwhile the flying rules from the current WH40K rulebook may be used with the following changes: the speed of the Eldar Jet Bike is reduced to 60" and any models flying off the table take no further part in the game. This prevents unscrupulous players from exploiting the ability of a jet bike to return to the table in a series of bombing runs which are impossible to either avoid or counter.

Type	Jet Bike
Fast Speed	32
Combat Speed	16
Slow Speed	10
Crew	1 Rider
Weapons	Twin Shuriken Catapults with a 45° field of fire to the front. These are synchronised to fire together. Roll once to hit – either both hit or both miss.

TWIN SHURIKEN CATAPULTS 45°

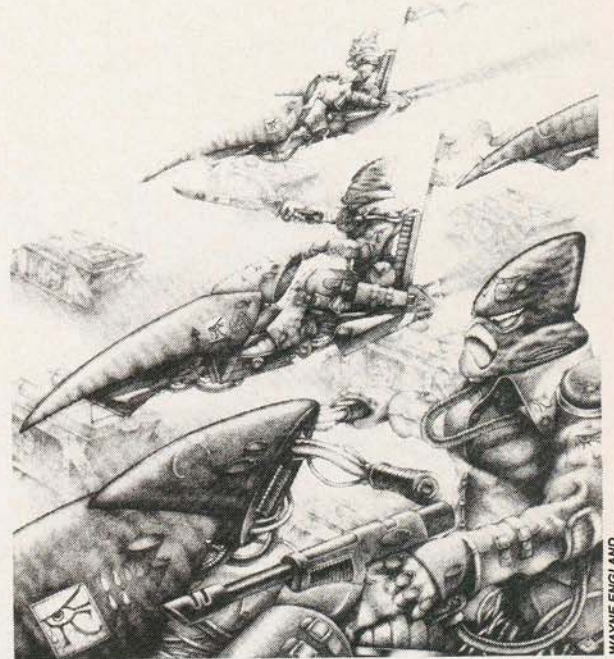
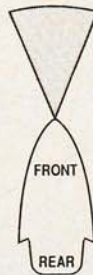

WAYNE ENGLAND

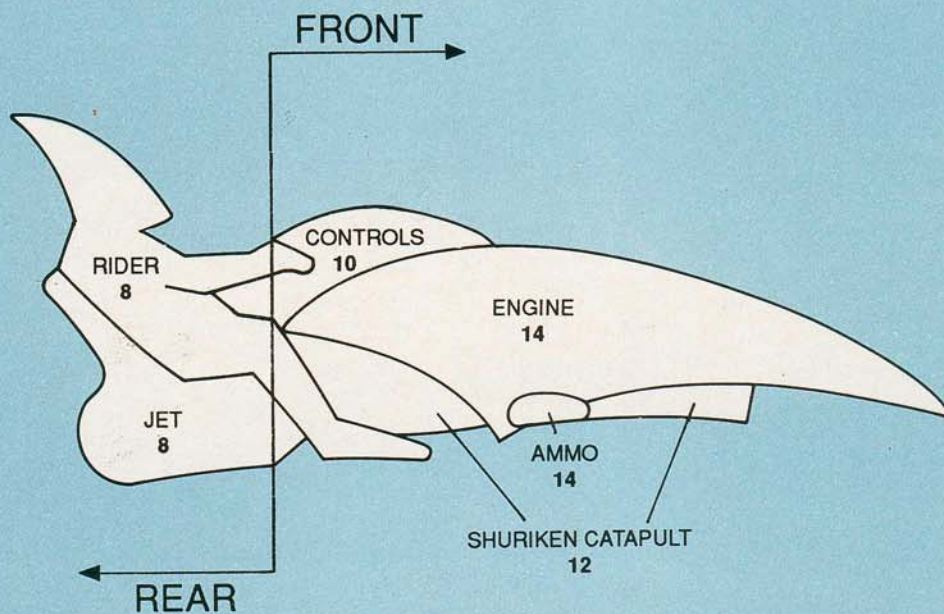

MA4 CHAOS ARMY

KAON THE IDOLATOR
CHAOS KNIGHT MOUNTED ON
WAR GRIFFON



VARSHAK DOOMBRINGER
CHAOS WARRIOR ON WARHORSE



BEASTMASTER AND 2 CHAOS HOUNDS



STEELHORN'S
MURDERERS
REGIMENT OF
20 BEASTMEN
INCLUDING LEADER,
STANDARD BEARER
AND MUSICIAN



MARAUDER MINIATURES ARE SUPPLIED UNPAINTED AND WITHOUT BANNERS

HAKEN'S REAVERS
REGIMENT OF 10 CHAOS THUGS INCLUDING LEADER, CHAMPION,
STANDARD BEARER AND MUSICIAN



DIETER'S MARAUDERS
REGIMENT OF 5 MOUNTED
CHAOS WARRIORS INCLUDING LEADER



GRIMNI THE TWISTED - CHAOS DWARF ALLIES
REGIMENT OF 20 CHAOS DWARFS
INCLUDING LEADER

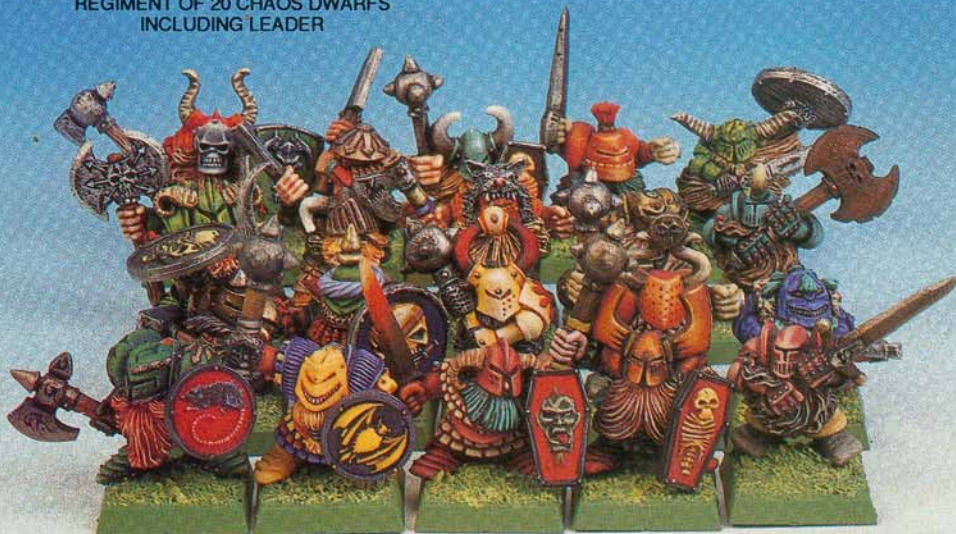

**MA4
CHAOS ARMY
£57**

For 1 War Griffon and Mounted
Chaos Warrior, 20 Beastmen, 10
Chaos Thugs,
5 Mounted Chaos Warriors,
20 Chaos Dwarfs,

PLUS FREE

MOUNTED CHAOS WARRIOR,
BEASTMASTER AND
2 CHAOS HOUNDS



3 DERBY TERRACE,
DERBY ROAD,
NOTTINGHAM,
NG7 1ND

**HOW TO MAIL
ORDER**

PLEASE SEND
ORDERS TO
MARAUDER
MINIATURES
MAIL ORDER,
3 DERBY TERRACE,
DERBY ROAD,
NOTTINGHAM,
NG7 1ND.
MAKE CHEQUES
PAYABLE TO
MARAUDER
MINIATURES
LIMITED.

POSTAGE AND
PACKING: MINIMUM
ORDER OF £5 WITH
A STANDARD
CHARGE OF £1 FOR
POSTAGE AND
PACKAGING.
ORDERS IN THE UK
OVER £20 DO NOT
HAVE A POSTAGE
AND PACKAGING
CHARGE.
PLEASE ALLOW 28
DAYS FOR
DELIVERY BUT
NORMALLY YOU
SHOULD RECEIVE
YOUR ORDER
WITHIN 10 DAYS.

FOREIGN ORDERS
YOU SHOULD
ORDER BY CREDIT
CARD
(ACCESS OR VISA),
INTERNATIONAL
MONEY ORDER OR
BY A CHEQUE
DRAWN ON A
BRITISH BANK. FOR
FOREIGN ORDERS
PLEASE SEND ALL
PAYMENTS PAID
OUT IN POUNDS
STERLING AND
MADE PAYABLE TO
MARAUDER
MINIATURES LTD.
THE MINIMUM
ORDER AMOUNT IS
£10 AND PLEASE
INCLUDE 40%
POSTAGE AND
PACKAGING. WE
WILL SEND YOUR
ORDER BY THE
FASTEST ROUTE
THAT THE POSTAGE
PAID ALLOWS.
PLEASE DO NOT
SEND CURRENCY
FOR PAYMENT OF
YOUR ORDER.

**HOW TO
TELEPHONE
ORDER VIA A
CARD ACCESS.**

SIMPLY TELEPHONE
YOUR ORDER
DIRECT TO US ON
0602 474878
BETWEEN 9.00am
AND 5.00pm ON
WEEKDAYS ONLY.
PLEASE HAVE THE
CARDHOLDER
PRESENT TO GIVE
AUTHORIZATION TO
THE TRANSACTION.

KAON'S DESPOILERS 2000 pt CHAOS ARMY

Kaon the Idolater was once a knight defending the realms of men from Chaos. He has long since been lured away down unspeakable paths into the worship of the powers he fought against. The Gods of Chaos have been generous to Kaon, their pawn, and word of his strength has spread, drawing a deadly band of followers about him.

Kaon has total confidence in his ability to meet opponents face to face and slay them. In battle he mounts his War Griffon and seeks out the enemy commander to destroy him and break his opponents' spirit before the forces meet. The Beastmen, Chaos Thugs and Marauder Horse are in the charge of Varshak Doombringer, Kaon's lieutenant. Varshak eagerly awaits the elevation or damnation of Kaon so that he may take over utterly – in the meantime he must be satisfied with command in battle alone.

Varshak first sends Grimni the Twisted and his Chaos Dwarves against the enemy, accompanied by the Beastmen. As they approach, the Marauder Horse and the Beastmaster follow closely behind while the Thugs ply their bows in support. Once close enough the whole force charges together to crush the toughest foes in the enemy line. Victory is always swift.

Kaon The Idolater – Chaos Knight (524 pts)

Army General – heavy armour, spell shield, riding beast: Griffon and magic sword: enchanted strike, hellhoned blade.

Varshak Doombringer – Chaos Warrior (136 pts)

Heavy armour, talismanic shield, warhorse with barding, lance and magic sword: parasitic blade.

Chaos Hounds (63 pts)

Beastmaster with light armour plus 2 Chaos Hounds.

Haken's Reavers – Chaos Thug Regiment (254 pts)

Leader – Chaos Warrior with light armour, bow, pistol and magic sword: banekblade, degeneration strike.

Champion – Chaos Marauder with light armour, bow, pistol and two-handed sword.

8 Chaos Thugs with light armour, bows and hand weapons, including standard bearer and musician.

Steelhorn's Murderers – Beastman Regiment (315 pts)

Leader – Banebeast with light armour, shield and hand weapon.

19 Beastmen with shields, throwing spears and hand weapons, including standard bearer and musician.

Dieter's Marauders – Marauder Horse Regiment (290 pts)

Leader – Chaos Warrior with heavy armour, shield, warhorse with barding, lance and sword.

4 Marauder Horse with heavy armour, shields, warhorses with barding, lances and hand weapons.

Grimni the Twisted – Chaos Dwarf Allies (418 pts)

Contingent Commander – Lvl 15 Chaos Dwarf Hero with spell-tempered heavy armour, shield and magic sword: mighty strike.

19 Chaos Dwarves with light armour, shields and hand weapons.

TOTAL ARMY POINTS VALUE – 2000 PTS



SPACE HULK™

GENESTEALER INVASION

MISSIONS FOR SPACE HULK, DEATHWING AND GENESTEALER

BY DEAN H. BASS

This is the final part of Genestealer Invasion, a Space Hulk campaign – we published the first part in White Dwarf 133. These missions can either be played as stand-alone games or as a campaign series of linked games where the outcome of each mission affects your chances in the next.

A huge space hulk has crash-landed on Septimus V. Its markings date from the Dark Age of Technology. Inside there may be valuable knowledge, lost to humanity for millennia. But the derelict spaceship also contains Genestealers, including powerful Hybrid psykers.

The first squads in were caught by surprise, ambushed while they were deep within the space hulk. The Genestealer defence was stronger than initial scouting had indicated and there was a high proportion of psykers. Many squads were wiped out, only those containing Librarians surviving the onslaught. The survivors regrouped, ready to counterattack when the second wave arrived, bringing with it the Space Marines' own strong psykers. The Stealers were caught between the fresh assault and the survivors breaking out – the action wasn't decisive but it bought the Space Marines time to plan a new attack.



PLAYING THE CAMPAIGN

If you want, you can play the missions that make up this campaign as one-off games in any order. However, it's more fun to play them as a campaign. If you are playing them as a campaign, use the following rules for how the outcome of each game affects the next.

Space Marine Victory

If the Space Marines win a game, the Genestealer player's choice of Hybrids is reduced for all the remaining games.

The Genestealer player should take all the lettered Blips and place them face down. The Space Marine player now gets to pick one of the Blips without seeing what letter it is – this Blip isn't available for use by the Genestealer player for the remainder of the campaign.

This means that if the Space Marine player keeps winning, after two games the Genestealer player is down to eight lettered Blips, after three games he's down to seven and so on.

Genestealer Victory

If the Genestealer player wins a game, the number of Space Marines is reduced for the next mission only (not for the rest of the campaign).

Because the Space Marine forces are different for each game, the Deployment section of the set-up instructions tells you which Space Marine is unavailable for that game if the Space Marines lost the last game.

Variants

For particularly skilful or experienced players, you can agree to increase the penalties for losing a game to two Space Marines or two Blips removed after each loss.

You can also choose to play these games using the bidding system from Deathwing and Genestealer. Both players bid points for the Space Marine forces and whoever bids lowest plays the Space Marines.

The Genestealer player receives the expanded Blip set and reinforcements as given in these missions

SEARCH AND DESTROY

During the fierce fighting of the break-out action, some squads found cryogenic tanks showing signs of recent use. It became clear to the Space Marine commander that there were many Genestealers, probably including Hybrid psykers, still in hibernation. If the Space Marines could locate and destroy these Hybrids before they awoke, their task in clearing the hulk would become much easier.

Squads were ordered to search for cryogenic tanks as they moved through the hulk. To give their commander a better idea of the enemy they were facing, the Space Marines were ordered to report on the contents of any cryogenic tanks they found. Once a tank's contents had been investigated, it was to be destroyed. Squad Gabriel, still at full strength and in a relatively clear area of the hulk, was one of those ordered to concentrate on searching for and destroying a cryogenic tank.

OBJECTIVES

The Space Marine player is trying to locate an occupied cryogenic tank in one of the six rooms. The Genestealer player is trying to stop the Space Marines from finding and destroying the tank.

FORCES

Space Marines

- One Sergeant with storm bolter and power sword.
- One Chief Librarian (level 4 psyker) with storm bolter and force axe.
- One Space Marine with assault cannon (see Special Rules) and power glove.
- One Space Marine with lightning claws.
- One Space Marine with storm bolter and power glove.

Campaign Forces

If the Space Marines lost the last game, they don't have the Space Marine with storm bolter and power glove.

Genestealers

The Genestealer player starts with 2 Blips and gets 1 Blip per turn as reinforcements. These are taken from the expanded Blip set but ambush counters cannot be used. The lettered Blips represent the following Hybrids:

- | | |
|---|--------------------------------------|
| A | Level 2 psyker with bolter |
| B | Level 2 psyker with chainsword |
| C | Level 2 psyker with laspistol |
| D | Level 2 psyker with plasma pistol |
| E | Level 3 psyker with autocannon |
| F | Level 3 psyker with missile launcher |
| G | Non-psyker with lascannon |
| H | Non-psyker with autocannon |
| I | Non-psyker with missile launcher |
| J | Non-psyker with conversion beamer |

DEPLOYMENT

Space Marines

The squad starts in the marked area.

The Space Marines move first.

Genestealers

The Genestealers can come on at any of the marked entry areas.

SPECIAL RULES

Both players use psychic cards.

The Space Marine can secure entry areas.

Finding the Cryogenic Tank

The first time a Space Marine gets direct LOS into a room that might contain the tank (as shown on the map), the Space Marine player rolls a dice. If the number rolled is a 6, that room contains the cryogenic tank. If not, then that room is empty. If three of the four rooms have turned up empty, the sixth room automatically has the tank in it. Once the tank has been located, the Genestealer player places the counter from Deathwing in the room in any position.

Completing the Mission

Once the tank has been found, the Space Marine player must check it out and destroy it. First a Space Marine must enter a square directly touching the tank and then spend a further 2 APs or CPs to report to the commander on the contents of the tank. Then the tank must be destroyed. Once the report has been made, any Space Marine may destroy the tank. For ranged weapons and psychic attacks, count the tank as being as tough as a Purestrain Genestealer. For close assaults, the attacking Space Marine must score a 7 or more to destroy it.

For example: a storm bolter destroys the tank on a roll of 6 on either dice; a Space Marine with a thunder hammer could destroy it on a roll of 5 or 6 (with the +2 bonus giving results of 7 or 8); a Lightning Arc psychic attack would give six chances, each needing a 3 or more to succeed.

Assault Cannon

The Space Marine with the assault cannon in this mission has already reloaded the weapon once and there is therefore a chance of malfunction. The Space Marine still has a reload for this mission.

VICTORY

The Space Marine player wins by making a full report on the cryogenic tank and then destroying it. The Genestealer player wins if no Space Marines reach the tank. If a Space Marine reaches the tank but fails to report or reports but the tank is not destroyed, the game is a draw.

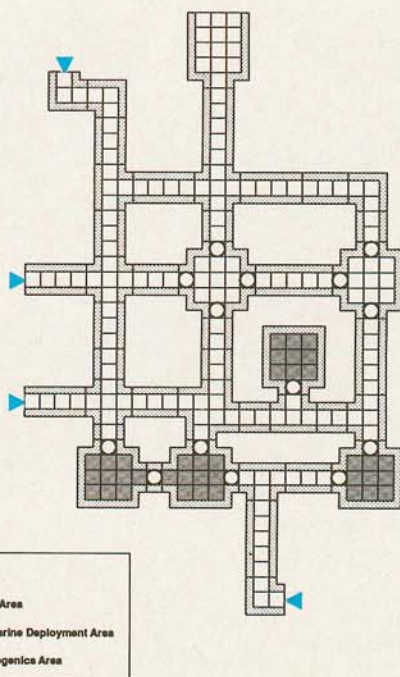

GAMES WORKSHOP™

OXFORD

GRAND OPENING

SAT 9th MARCH

NEW INN HALL STREET

TEL: (0865) 242182

Normal Hours: 11am-8pm Mon-Fri
9.30am-5.30pm Sat



BUY ANY 2 RED DOT ITEMS AND GET 1 YELLOW DOT ITEM FREE!

EG: BUY SPACE HULK AND ADVANCED HEROQUEST AND GET DEATHWING FREE!

BUY ANY 2 BLISTER PACKS AT £2.99 OR OVER AND GET ONE ADDITIONAL £2.99 BLISTER PACK FREE!

BUY ANY 3 EPIC MINIATURE BOXES AND SAVE £4

BUY ANY 3 PAINT SETS AND SAVE £3

LOTS OF GAMES & ACCESSORIES FOR £2.50 OR LESS

OFFERS LAST ALL DAY (WHILE STOCKS LAST)

PLEASE NOTE: YOU CANNOT USE THE VOUCHERS WITH ANY OF THE ABOVE OFFERS



SPECIAL DISCOUNT BARGAINS ALL DAY!



ONLY ONE VOUCHER PER PRODUCT REDEEMABLE AT GAMES WORKSHOP OXFORD SAT 9th MARCH

10 % OFF

ANY GAMES WORKSHOP OR CITADEL PRODUCT

NOT TO BE USED WITH ANY OTHER OFFER

ONLY ONE VOUCHER PER PRODUCT REDEEMABLE AT GAMES WORKSHOP OXFORD SAT 9th MARCH

10 % OFF

ANY GAMES WORKSHOP OR CITADEL PRODUCT

NOT TO BE USED WITH ANY OTHER OFFER

ONLY ONE VOUCHER PER PRODUCT REDEEMABLE AT GAMES WORKSHOP OXFORD SAT 9th MARCH

25 % OFF

ANY GAMES WORKSHOP OR CITADEL PRODUCT

NOT TO BE USED WITH ANY OTHER OFFER

ONLY ONE VOUCHER PER PRODUCT REDEEMABLE AT GAMES WORKSHOP OXFORD SAT 9th MARCH

25 % OFF

ANY GAMES WORKSHOP OR CITADEL PRODUCT

NOT TO BE USED WITH ANY OTHER OFFER

DOORS OPEN 9AM

WHITE DWARF

Make sure you don't miss
a single issue of
WHITE DWARF magazine.
Subscribe now
and have the
next 12 issues delivered
straight to you.



Every month **WHITE DWARF** - Games Workshop's hobby magazine - provides rules expansions and new material for our growing range of games. We keep you up to date on the developments of *Warhammer Fantasy Battle*, *Warhammer 40,000*, *Warhammer Fantasy Roleplay*, *Blood Bowl*, *Mighty Empires*, *Space Marine*, *Space Hulk*, *Advanced Space Crusade* and *Advanced Heroquest*.

WHITE DWARF provides you with news on the latest releases from Citadel Miniatures.

In every issue you'll find articles on painting and converting Citadel Miniatures for use in your games.

You cannot afford to miss out every month. Recent issues of **WHITE DWARF** have completely sold out - so subscribe now to make sure of your copy.

A year's subscription to **White Dwarf** (12 issues) is just £20 for UK residents and \$35 for US residents.



WHITE DWARF MAGAZINE SUBSCRIPTIONS,
Games Workshop, Chewton Street,
Hilltop, Eastwood, Notts NG16 3HY

**(0773) 713213 or
(0773) 760462**



WHITE DWARF MAGAZINE SUBSCRIPTIONS,
Games Workshop Inc., 3431 Benson Ave,
Baltimore, Maryland 21227

(301) 644 5699



For VISA, ACCESS and MASTERCARD subscriptions please have the cardholder present to authorise the transaction.

SUBSCRIBE NOW!

HOLD AND SECURE

As the Space Marine commander analysed the reports from his squads, it became clear that the crashed hulk contained a high proportion of Hybrids – and many of those encountered were psykers. At the same time, the mysterious source of psychic energy deep within the ship was growing ever stronger. All the evidence pointed to the presence of a Genestealer Patriarch, the most powerful of Genestealer psykers, whose presence would threaten the survival of the Space Marines assaulting the hulk.

It was obvious that, as yet, the Patriarch was still partially dormant from his long voyage through space. But the stirrings of his power were becoming stronger. If the Space Marines couldn't locate and destroy him before he regained his full power, their mission was surely doomed. They had to strike hard and fast before the Patriarch awoke and took control of his brood but it was a dangerous race against time – the Space Marines first had to locate the dormant Patriarch.

Following the guidance of their Librarians, they closed in on the core of cold fury that seemed to burn at the heart of the ship. If they could secure several key areas, they would win the chance to launch a fast and deadly strike to destroy the Patriarch before they were overrun.

OBJECTIVES

The Space Marine player is attempting to secure all the Genestealer entry points. The Genestealer player is trying to kill as many Space Marines as possible to stop this happening.

FORCES

Space Marines

- One Captain with storm bolter, power sword and power glove with grenade launcher.
- One Chief Librarian (level 4 psyker) with storm bolter and force axe.
- One Epistolary (level 3 psyker) with storm bolter and force axe.
- One Space Marine with flamer and power glove.
- One Space Marine with thunder hammer and storm shield.
- One Space Marine with storm bolter and chain fist.
- Two Space Marines with storm bolters and power gloves.

Campaign Forces

If the Space Marines lost the last game, they don't have the Space Marine with storm bolter and chain fist. In addition, the Epistolary is replaced by a Codicier (level 2 psyker).

Genestealers

The Genestealer player doesn't get any starting forces but receives 2 Blips per turn as reinforcements (unless directed otherwise by the Special Rules on securing areas). The lettered Blips represent the following Hybrids:

- A Level 3 psyker with bolt pistol
- B Level 3 psyker with power sword
- C Level 3 psyker with lasgun
- D Level 4 psyker with plasma gun
- E Level 4 psyker with bolter and chainsword
- F Level 4 psyker with heavy bolter
- G Non-psyker with heavy plasma gun
- H Non-psyker with autocannon
- I Non-psyker with missile launcher
- J Non-psyker with conversion beamer

DEPLOYMENT

Space Marines

The Space Marines start in the marked room.

The Space Marines move first.

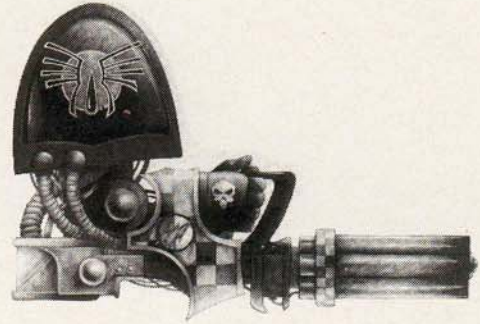

Genestealers

One Blip per turn must arrive at the special entry point (see Special Rules) but the other Blip can arrive at any of the entry points.

SPECIAL RULES

Both players use psychic cards.

Securing Areas

The Space Marine player is attempting to secure all the Genestealer entry points as per the Deathwing rules. The special entry point is a ladder coming up from a service tunnel running under the room. If the special entry point is secured, the Genestealer player is reduced to 1 reinforcement Blip per turn.

VICTORY

The game ends at the end phase of turn 15. If all the entry points have been secured, the Space Marine player wins. If all the Space Marines are dead and at least one entry point is still open, the Genestealer player wins. Any other result is a draw.

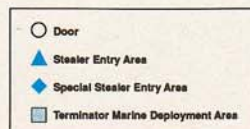
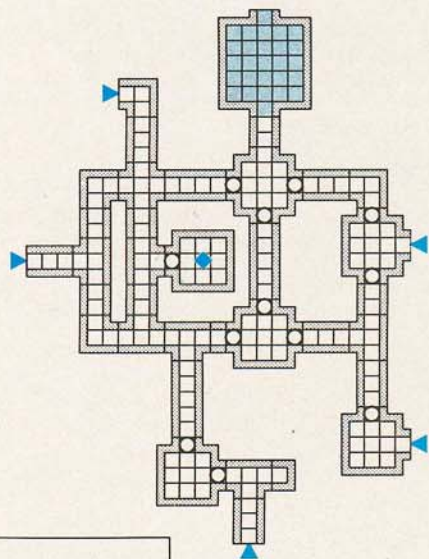

FINAL CONFLICT



TONY HOUGH

As squads secured their areas and reported them clear, the Patriarch's location was narrowed down to one small area of the hulk. The nearest Space Marines were dispatched to destroy the Patriarch before it had fully recovered from hibernation. There was no time to assemble a full attack force – the Marines at hand would have to act fast and decisively to remove the threat.

With the Patriarch destroyed, the remaining Stealers would be disorientated and without guidance – it would be a long, hard to fight to kill them all, but in the end the outcome was certain. If the Patriarch survived, the Marines in the hulk were almost certainly doomed – those outside would have to stand off and destroy the hulk by bombardment, losing any valuable information about its origin that might have been recovered from the data banks inside.

While the other Space Marines were ordered to break out of their positions to cause a diversion, a three-pronged attack was launched, led by Captain Raphael with the support of two Chief Librarians to overcome the ever-strengthening psychic defences of the Stealers. The success of this whole operation now depended upon the actions of these few Marines who were fighting for their own and their brothers' lives.

OBJECTIVES

The Space Marine player is trying to kill the Patriarch before it awakes and the Genestealer player is trying to wipe out the attackers before they reach the Patriarch's room.

FORCES

Space Marines

The Space Marine player splits the following force into three units of three. The two Chief Librarians must be in different units.

- One Captain with storm bolter, power sword and power glove with grenade launcher.
- Two Chief Librarians (level 4 psykers) with storm bolters, force axes.
- One Space Marine with assault cannon (one reload) and power glove.
- One Space Marine with flamer and power glove.
- One Space Marine with lightning claws.
- One Space Marine with thunder hammer and storm shield.
- One Space Marine with storm bolter and chain fist.
- One Space Marine with storm bolter and power glove.

Campaign Forces

If the Space Marines lost the last game, they don't have the Space Marine with thunder hammer and storm shield. In addition, one of the Chief Librarians is replaced by an Epistolary (level 3 psyker).

Genestealers

The Genestealer player starts with 3 Blips. Reinforcements are 1 Blip per turn for the first two turns and 2 Blips per turn from then on. These are taken from the expanded Blip deck and ambush counters may be used as detailed in the Special Rules. The lettered Blips represent the following Hybrids:

- A Level 3 psyker with autocannon
- B Level 3 psyker with missile launcher
- C Level 3 psyker with conversion beamer
- D Level 4 psyker with heavy bolter
- E Level 4 psyker with plasma pistol and power sword
- F Level 4 psyker with heavy bolter
- G Level 4 psyker with heavy plasma gun
- H Non-psyker with autocannon
- I Non-psyker with missile launcher
- J Non-psyker with conversion beamer

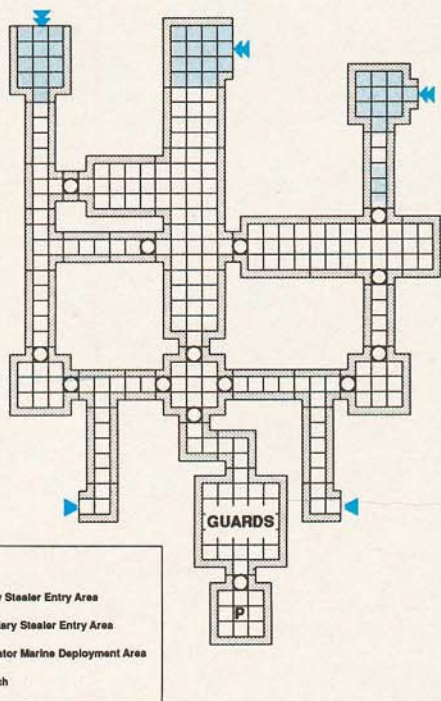

○ Door
 ▲ Primary Stealer Entry Area
 ▲ Secondary Stealer Entry Area
 ■ Terminator Marine Deployment Area
 [P] Patriarch



TONY HOUGH

DEPLOYMENT

Space Marines

One unit starts in each of the three marked deployment areas.

The Space Marines move first.

Genestealer

The 3 starting Blips are placed in the room marked Guards. One reinforcement Blip must come on at a primary entry point. When 2 Blips are allowed, the second one must come on at a secondary entry point. A Patriarch model is placed in the marked room in either of the rear corners.

SPECIAL RULES

Psychic Cards

Both players use psychic cards. For the first two turns, the Genestealer player has a hand of 4 cards. For turns 3 to 9, the Genestealer player has 5 cards as the Patriarch begins to wake. From turn 10 onwards, the Genestealer player has 6 cards as the Patriarch is fully awake.

Guards

The 3 Blips in the room marked Guards must stay in that room. They are the last line of defence. They may be converted at any time and may fire or make psychic attacks out of the room, but cannot leave the room. They are placed by the Genestealer player with any facing required and in overwatch if possible and if desired.

Ambush Counters

If the Genestealer player uses an ambush counter and it is revealed as a Genestealer, the Genestealer is not a Purestrain as normal but an unarmed level 4 Hybrid psyker which has teleported into the area. Obviously, the Genestealer player has to choose whether to draw ambush counters in an attempt to get a psyker or keep drawing normal Blips.

The Patriarch

The room marked on the map contains the Patriarch. Until turn 10, the Patriarch is still partially dormant and cannot fight or make psychic attacks itself. From turn 10 onwards, the Patriarch is fully awake.

Once awake, the Patriarch has 6 APs like other Purestrain Genestealers but rolls 4 dice in close assault, each with a +3 bonus. Whether it's partially dormant or fully awake, the roll to kill the Patriarch is the same as that for a Purestrain Genestealer.

Crates/Rubble

The players take it in turns (Space Marine player first) to place all the crate and rubble counters in the 3-wide corridor sections. These cannot be placed where they would block movement totally – there must always be a clear route through.

VICTORY

The game ends when either the Patriarch has been killed or all of the Space Marines have been killed. If the Patriarch is killed before it is fully awake (ie before turn 10), the Space Marine player wins. If the Space Marines fail to even enter the Patriarch's room, the Genestealer player wins. Anything else is a draw.

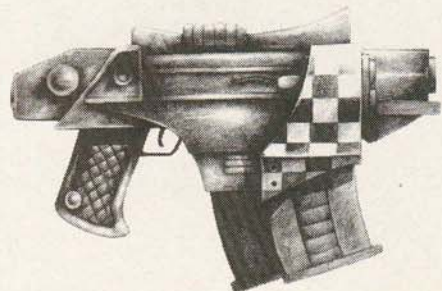



This month we return to Potion Square, to look at a few of the area's smaller traders. As the Square's nickname suggests, the trade in medical, magical and alchemical ingredients is brisk hereabouts.

We've already met Wilhelm Rotkopf the Alchemist and visited Jan van Arzneier's Floracopoeia in WD128 and 126 - this time we meet Arabian spice merchant Hassan. Some of the locals think there's more to Hassan than a simple foreign spice-trader with a gift for haggling, but that may be just because he's from Araby. Most Old Worlders are ready to believe that anyone from that mysterious land is a dangerous sorcerer. But if you need anything from cooking spices to simple magical ingredients Hassan's is a good place to start.

Moving on, the Sign of the Quill provides anything you could ever need in the way of writing implements and supplies - and if you can't read or write yourself, then proprietor Dirck Oester will be more than happy to do your reading and writing for you - for a good price, of course!

The two cottages between the Quill and Droevigger's Funeral Emporium (which we'll visit on a future occasion) are now a warehouse and caretaker's cottage owned by absentee landlord Artur Dagblad, who has at least one finger in the local leather trade. But leather isn't all that you might find in Dagblad's 'lockup' if you look carefully! The leather trade also provides a living for tanner Anton Loewijer and his two apprentices. It's a fascinating craft - if a slightly malodorous one.

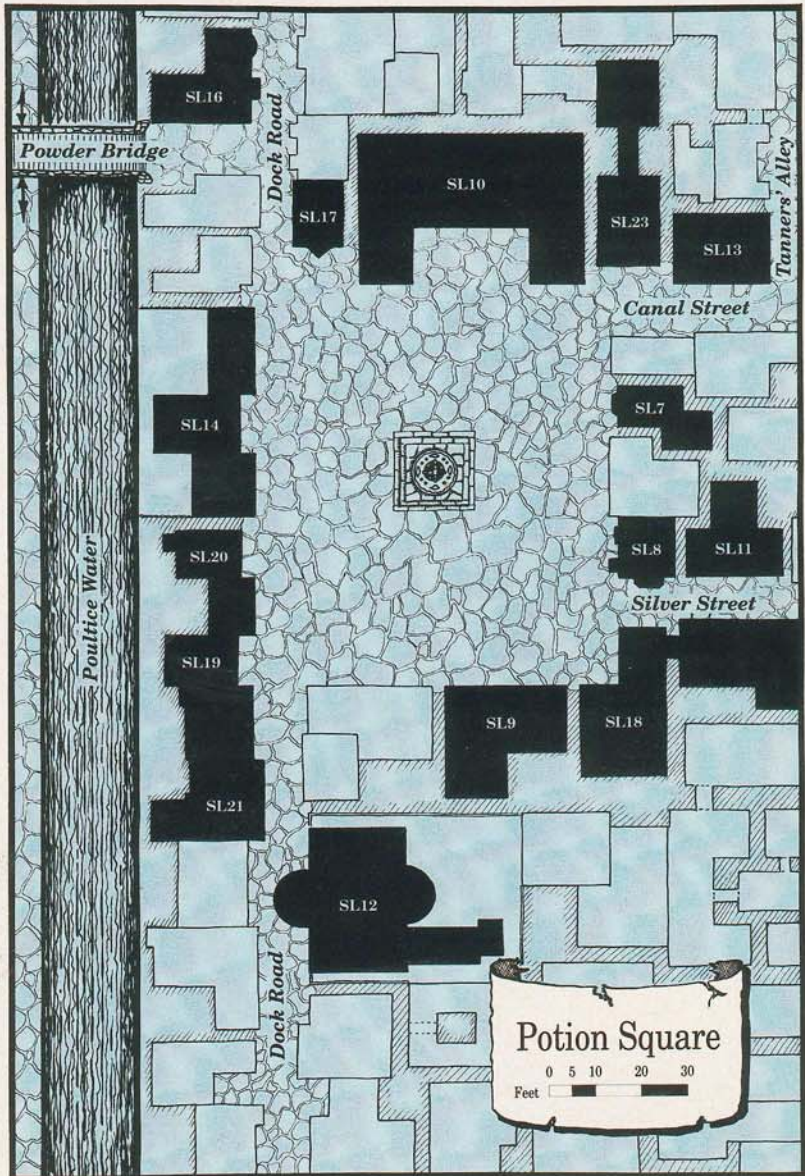

HASSAN'S SL17



Between the Edelmoed Temple and Dock Road there stands a very strange little building, with an equally strange sign hanging outside – an iron wedge jammed into a carved wooden fruit of some sort. There is no other sign or name-plate, but the stoppered glass jars of dried fruits and powders in the windows give a clue that here one may buy spices. This impression is confirmed upon entering the shop. The mixture of aromas is almost overwhelming.

A small, wiry, dark-skinned man rises from a chair behind the counter as the customer enters, bows formally, and speaks in cultured tones, but with a noticeable Arabian accent: "Enter and be welcome. My humble shop is at your service. How may I assist you?"

Hassan's shop is a small, dark place, crammed with drawers and jars of herbs, spices and other ingredients. Upstairs, he has a small office and sitting room where he entertains 'special' customers. Some of the business which is transacted in the privacy of the upstairs room may not be entirely legal...

Common Knowledge

"It's not right, I tell you. Bringing his heathen practices into a civilised country – and right next door to the temple, too! We're too soft on these furriners. No good'll come of it, you mark my words!"

"Whole place is the wrong way round if you ask me. I mean, look at the frontage. All windows, and that bay poking out – it's the natural place for a door. But is the door there? No. It's round the side on Dock Road, set into a blank wall. You can't tell me it's not like that for a purpose. There's something not right there, that's for sure."

"It's a funny place, right enough, but Hassan's all right when you get to know him. Always has the best stuff, too. A lot of people are wary of him, but that's just because he's Arabian, I reckon. Don't see a lot of them around here – they mainly keep to their little enclave up around Havensdijk, along with the other foreign merchants."

"They say he's connected with one of the big Arabian merchants up on Havensdijk – second cousin of someone's brother-in-law or something. He must have contacts to get hold of the stuff he sells. He knows his stuff, too. People come to Hassan's from all over the city, and not just the occasional Halfling after some seasonings. If you know what you're doing, there's a lot you can get from Hassan."

"There's more to that one than meets the eye..."

Hassan bin Naroun al-Asred, Merchant, ex-Trader, ex-Herbalist, ex-Wizard's Apprentice (SL17a)

"Welcome to my humble place of business. Here most assuredly you will find what you seek."

"Aaah, but observe – the colour, the texture, the aroma. This is of the very best – fit for the table of the Sultan himself! Already I must face the angry ghosts of my forefathers for offering it at such a price! For my soul, I cannot go one penny lower."

"Five Guilders? I would not take so little for a single hair from my beard! Hassan does no business with thieves!"

"What you ask is clearly impossible. The Sultan himself has decreed that this spice is never to leave the shores of Araby, on pain of death to the faithless merchant who ships it. I will do what I can, but the price will be high. Return in two weeks."

"Son of a dog, you exhaust me utterly. Take it, take it and give me your filthy money. I betray my trade, my nation and my family by selling at this price – I shall starve and my soul be torn by evil spirits for such dealings, but take it, you shameless robber! May worms eat your guts, you bandit, and may you taste the poverty your dealings force upon my blameless head!"

Hassan is a shortish, hawk-faced, wiry man in his late thirties. His black beard and moustache are impeccably trimmed, and he always wears a turban of black or purple silk secured by a ruby-topped pin. He dresses in the loose clothing of Araby, wearing brightly-coloured silks and satins in combinations that no Old Worlder could carry off. In winter, he adds a fine wine-coloured velvet cloak against the cold and damp.

Hassan's manner is faultlessly polite when dealing with a customer, but he is a very spirited haggler and engages in bargaining with an enthusiasm that Old Worlders sometimes find unnerving. Even the more genteel Marienburgers among his clientele sometimes have trouble keeping up with the unending flow of refusals, threats, pleas and insults that make up a typical Arabian bargaining session.

Hassan deals mainly in spices brought in from Araby. Despite rumours of powerful connections amongst the resident Arabian merchants, he works more or less alone, dealing directly with ships' captains. They are generally happy to bring in an extra sack or two, and Hassan's extensive contacts among the Arabian crews mean that he is able to maintain a steady supply of almost anything.

As well as the more conventional spices, Hassan has been known to deal in more exotic substances from Araby, trading Old World herbs and rarities back to his homeland. Several of the city's wizards rely on Hassan for certain spell ingredients, and more than one of Marienburg's merchant princes has found him useful in obtaining Arabian antiquities and other exotic items with which to impress friends and rivals. Despite the fact that he is not formally attached to any of the Arabian mercantile concerns in the city, Hassan has numerous friends and contacts among the resident Arabians.

Marienburg

He occasionally obtains exotic herbs for Jan van Arzner (SL9a), and Wilhelm Rotkopf (SL12a) buys ingredients from him regularly. He is licensed by the Guild of Wizards and Alchemists (C22) to sell spell ingredients, and a framed certificate to this effect hangs on the wall behind the counter. Hassan has never done business with Grossbart (SL18c) – he knows there is a drug den in the Long Dragon but is not inclined to become involved. Grossbart, for his part, is aware of Hassan's dealings, but is letting him be for the moment.

M WS BS S T W I A Dex Ld Int Cl WP Fel
4 43 38 3 4 9 52 1 44 57 63 51 53 50

Age: 37

Alignment: Neutral

Skills: Acute Hearing; Ambidextrous; Arcane Language – Magick (Arabian); Blather; Cast Spells – see below: Evaluate; Haggle*; Herb Lore; Identify Plant; Law; Magical Sense; Manufacture Drugs; Numismatics; Prepare Poisons; Read/Write; Scroll Lore; Secret Language – Ancient Arabian; Speak Additional Language – Old Worlder; Super Numerate.

* Hassan gains a +20 modifier for this skill, instead of the usual +10.

Spells: 7 Magic Points

Petty *Curse; Gift of Tongues; Magic Alarm; Magic Flame; Reinforce Door; Sleep; Sounds; Zone of Warmth.*

Possessions: dagger (I +10, D -2, P -20) in sheath that automatically coats the blade with 2-dose Manbane blade venom when it is drawn (must be refilled after 2 uses); spell ingredients; personal jewellery worth 50 Gu total.

Trading at Hassan's

As well as a range of culinary spices, Hassan stocks a few herbs and ingredients for most legal spells (ie not Necromantic or Daemonic) up to level 2. Spell ingredients cost 1 Gu for Petty Magic, and 2GU per level for other spells – this price gets enough for a single casting of the spell. You might want to alter this price if an ingredient is particularly mundane (eg a piece of wax) or particularly exotic (eg the tongue of a Harpy).

As we've already said, Hassan is very fond of haggling. He will always demand twice the normal price for an item, and will haggle normally down to 120% of the normal price. At this point, his bargaining becomes more heated as he calls upon the full 20% bonus conferred by his exceptional *Haggle* skill. He can be bargained down to 100% of the normal price, but only after a lot of protests, imprecations, insults and general histrionics. He *never* sells at less than 100%. It is up to you to decide exactly what Hassan has in stock at any time – you might have special reasons for wanting the adventurers to be able to get hold of certain spell ingredients – or not!

If the adventurers ever need to get hold of something rare or exotic, there's a chance that they will find it at Hassan's. You might also use him to introduce them to various adventures connected with the stranger items among his stock.

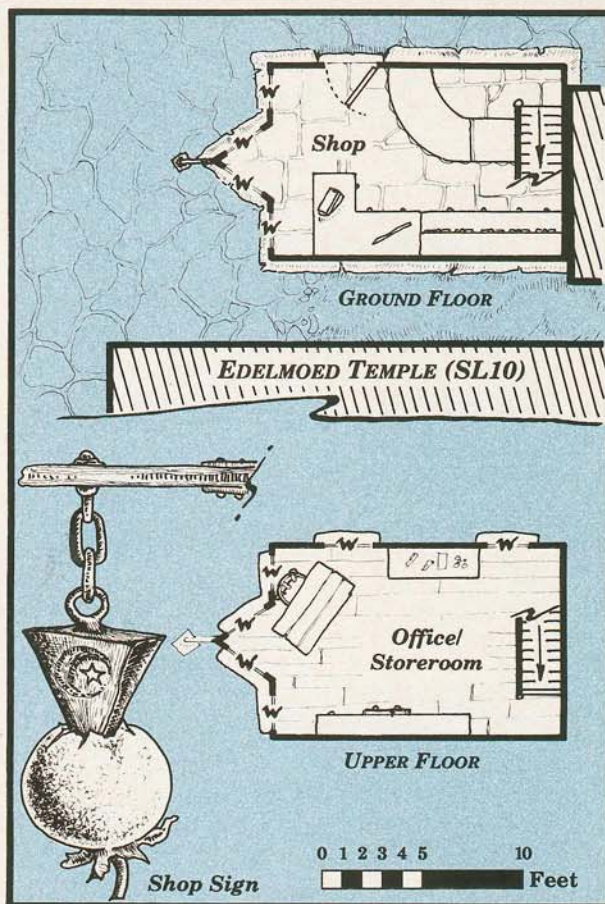

Security Measures

Hassan does not live on the premises, and his shop is equipped with several anti-burglar measures. Firstly, the lock on the door is magical, and Hassan carries the only key; the enchanted lock casts the Petty Magic spells *Magic Lock* and *Reinforce Door*. The lock cannot be opened other than with the correct key, and it also boosts its resistance to being broken down, giving it T 6, D 8.

All the windows have a low-power enchantment in the glass (a variant on the Petty Magic spell *Sounds*). No matter how carefully a would-be burglar breaks a window, it always makes a *loud* noise across the Square (SL7). The enchantment will even negate a *Zone of Silence* 20% of the time. The security measures continue inside the shop. As he leaves, Hassan stands a decorated ceramic tile on the counter – a gift from an Arabian wizard of his acquaintance. At first glance it looks like a fairly cheap Arabian *objet d'art*, but in fact it has two spell runes worked into it: *Cause Panic* and *Cause Cowardly Flight*. The runes are activated by anyone except Hassan coming within 2 yards of the tile, and the *Cause Panic* rune activates slightly before the other. The effects are as given in the *WFRP* rulebook:

Test	Pass	Fail
1st WP test	make 2nd WP test	Flee
2nd WP test	no effect	make Ld test
Ld test	no effect	Flee

Finally, Hassan has four *Enchanted Ropes* imported from his native land. He leaves them wandering the shop at night, with orders to attack and bind anyone who enters except him.

THE SIGN OF THE QUILL SL20

This small shop stands next door to the Marienburg Home for Foundlings (SL14) on Potion Square. A narrow alley separates it from the orphanage, and it forms a block with Dagblad's Wholesale Leathers (SL19) and Droevigger's Funeral Services (SL21).

Outside the door hangs a wooden model of a quill pen, about three feet long. Anyone entering the shop will find themselves confined to one corner by a scrubbed pine counter; the rest of the shop is filled with racks and cupboards containing pens, inks, sandboxes, sheets of parchment and vellum, and other writing equipment. Against one wall, under a pair of oil-lamps, stands a large writing-desk, and it is here that the proprietor will most often be found working. As well as offering writing equipment to the literate, the Sign of the Quill also offers basic literary services to the unskilled.

Common Knowledge

"The Quill? Sells parchment, I think. Writing stuff. Never had much use for it myself."

"Oester does a fair-quality vellum, but you have to watch



him. Check every sheet carefully – if he's got a faulty one he'll often try to get rid of it by slipping it in the middle of a stack so you don't notice."

"Oh, yes, he does all that writin' stuff. A couple of years ago my Uncle Hendrik got rammed by a drunk Bretonnian in the Brunwasser, an' there was all this writin' to go through with the courts an' that – well, Uncle was quite worried. I mean, you don't need writin' to run a lighter off Stoessel, so he never got round to learnin'. Oester saw him right, though – read all the stuff out to him and writ down what Uncle had to say for himself. Turned out sweet as ale in the end."

"Mention my name and tell him you're after a scroll-quality vellum. He'll quote you a price alright! Don't budge above a Guilder a sheet, though – he'll come down eventually."

Dirck Oester (SL20a), Charlatan, ex-Forged, ex-Scribe, ex-Trader (Initiate of Ranald)

"The four-shilling parchment? Weellll... it's all right for doodling, I suppose – notes and the like. But for a finished piece of writing, I'd say you really need the ten-shilling. Look – see the finish on that? Now compare it with the four-shilling. See what I mean?"

"Now here's a quill for you. Take a look. What is it? Guess. You can tell at a glance it's not swan or goose. Give up? Genuine Pegasus feather, that is. I happen to know this wizard in Elftown, you see – every so often I'll do him a little favour and he'll send me a few of these from his stable. Beautiful quill, Pegasus – holds a point like nothing you've ever seen. Doesn't flake or chip like a bird's quill. Master Rotkopf across the way there, he won't use anything else. Knows his stuff, does that gentleman. Five Guilders, to you."

"What's that, then, Granny? Ohhh – looks official. Seal on the back and everything. What've you been up to, then? You been out with your little lamp leading ships onto Breukrots again? Ha ha! 'Course I'll read it for you – oh, don't you worry, just give me one of your sausages and we're even."

Dirck Oester is a fresh-faced, slim man; his tousled ginger hair and freckles make him look younger than his age. He was apprenticed as a scribe to one of the merchant houses, but quickly became dissatisfied with the pay and lack of interest in the job. He rents this small shop from Artur Dagblad (CK12) and makes a living from his knowledge of writing and writing materials. He is a quick-witted individual with a certain roguish charm, and most of his customers agree that you have to keep your wits about you when dealing with him.

Most of his customers and acquaintances don't know that Oester is an Initiate in the cult of Ranald, although few would be surprised to find out. He is a member of

Marienburg

Edvard Strattner's (SL33a) shrine club, like his neighbour Albert Waarmans (SL19a), and in a chest in his bedroom he keeps a small folding shrine dedicated to Ranald the Deceiver. While he is capable of all kinds of sharp practice, he has a soft spot for the poor and needy, and will work for them free of charge if they genuinely can't afford to pay.

Oester supplies writing materials to many of the physicians on nearby Leech Street, and Wilhelm Rotkopf (SL12a) is one of his regular customers. The two have worked together on a number of occasions to develop special inks for inscribing magical and arcane scrolls and books. He gives parchment scraps and off-cuts to Sister Marianne (SL14a) for use in the orphanage's classes, and has provided letters of introduction which have helped a few of the orphans to apprenticeships as scribes. Oester has contacts right across the social scale in Suiddock, and will sometimes supplement the income from his shop by rather less respectable means – the occasional forgery of a bill of lading or other official document, for instance. He also uses the warehouse next door to hide contraband for Matteus Pijk (SS22a). This operation is so well hidden that even Grossbart (SL18c) knows nothing of it, although Lea-Jan Cobbius (SR5a) is aware of the operation. He finds out well in advance when the warehouse is to be cleared, and makes sure that the 'goods' are moved out beforehand – for one thing it's too good a dodge to let it be discovered, and for another he would hate Albert to get into trouble on his account.

M WS BS S T W I A Dex Ld Int Cl WP Fel
4 33 50 3 4 10 41 1 63 39 58 51 53 55

Age: 32

Alignment: Neutral (Ranald)

Skills: Arcane Language – Magick; Art; Blather; Charm; Evaluate; Haggle; Law; Numismatics; Read/Write; Scroll Lore; Secret Language – Classical; Super Numerate; Theology; Wit.

Possessions: dagger (I +10, D -2, P -20); assorted writing materials (always has a quill tucked behind his ear).

THE GOODS

At any time, there is a 20% chance that Oester has hidden some contraband in Dagblad's warehouse. The things he stores are always small and of high value – it's not practical to hide a ship-load of untaxed corn in a small warehouse! Oester has no part in the smuggling operation, but simply provides a hiding-place for illicit goods until they can be moved. The contraband can vary widely – Bretonnian and Imperial brandy is frequently smuggled in, as are fine wines from almost every part of the Old World. Jewellery and precious stones are small, valuable and easy to smuggle – jade from Lustria or Cathay and worked amber from Norsca – and antiquities and *objects d'art* from almost anywhere can find its way into Marienburg. A cache of contraband will be worth anything from a few dozen Guilders to a few hundred – roll a D6, note the score and roll D100 that many times. Add the scores together to find the value of the contraband in Guilders.

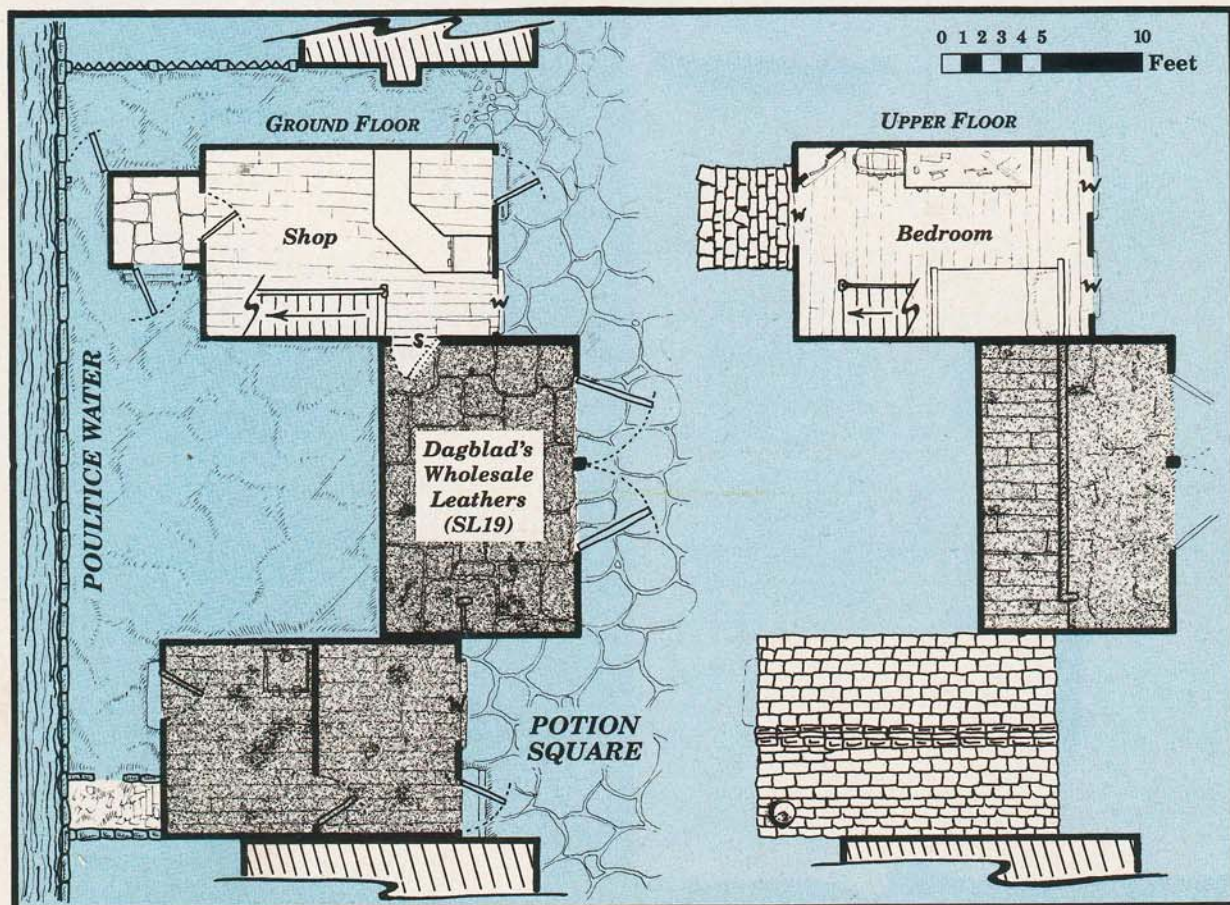

DAGBLAD'S WHOLESALE LEATHERS SL19

The row of buildings which back onto the Poultrice Water were all originally small houses, but many, like the Marienburg Home for Foundlings (SL14), have been adapted to other uses. Dagblad's consists of two houses, next-door-but-one to the orphanage. One has been converted into a small warehouse, and Albert Waarmans the caretaker lives in the other.

The two buildings are owned by Artur Dagblad (CK12), but he hardly ever visits them, having many interests elsewhere. Their main business is simply to store made-up leather goods before they are moved on to other parts of the city for sale. Occasionally Dagblad will arrange for other things to be stored here, but the warehouse's main business is leathers from nearby Tanner's Alley and Shoemaker's Square.

Albert's shack is a single-storey, two-room affair. He sleeps and cooks in the back, which is fitted with a small stove; firewood is kept outside in a small roofless pen built into the wall of the yard. The front room is a blend of parlour and office, with a rickety table scattered with miscellaneous paperwork and writing kit, and a comfortable but slightly battered chair right by

the window. It is here that Albert spends most of his days, watching the world go by outside. On a fine summer day, he will even drag his chair into the doorway. There is a trapdoor in the floor of the back room which presumably leads down to some kind of cellar, but Albert has never opened it and has no idea what might be in there. It's left to your discretion as GM to decide where this trapdoor really leads - the sewers, perhaps?

The 'lockup' was originally a small two-storey house, but has been radically altered. A narrow loft, reached by ladder from the ground, is all that remains of the upper floor, and a tall double-doorway has been cut into the front of the building. The back door which originally led out to the yard has been bricked and plastered; now the doorway is visible only from the outside. Neither Albert nor Dagblad is aware of the secret door leading into Dirck Oester's shop (SL20).

Common Knowledge

"That? Warehouse of some kind, I think. Saw them moving some leather jerkins in there once. The old boy next door seems to be some kind of caretaker."

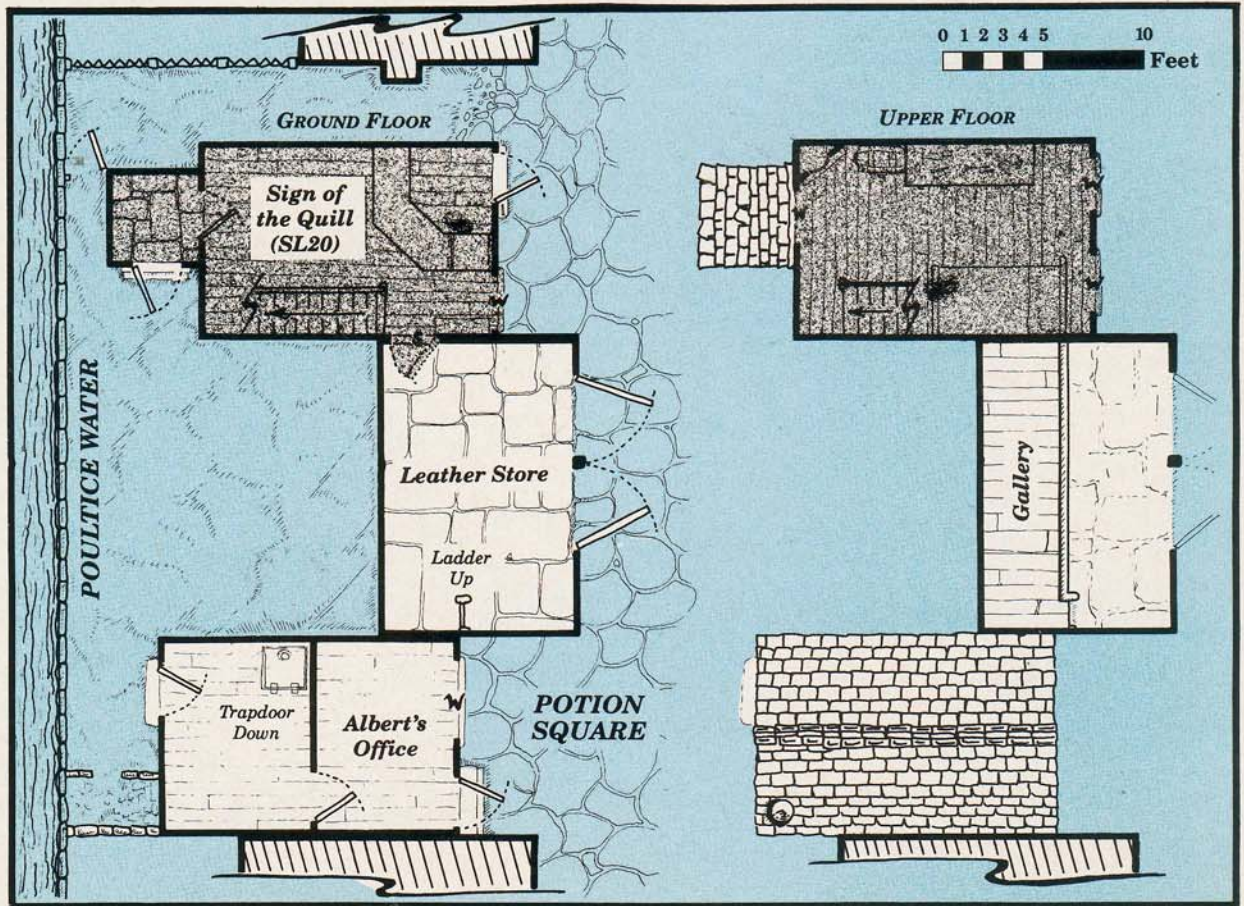

Marienburg

"Cushiest job in the docks, old Albert's got. All he has to do is sit there all day in his shack. I mean, who's going to rob a warehouse full of cheap leathers?"

"Never met Dagblad, but he seems to look after old Albert all right. Still, at his age he's entitled to an easier life, I reckon. Not that he takes it particularly easy in the Long Dragon of an evening, but that's another story."

Albert Waarmans, Servant, ex-Labourer

"What d'ye think to this weather, then? Not bad for the time of year, eh?"

"GERRADAVIT! Oh, sorry, boss – thought you was another o'them kids from the orphanage. 'Ave t'keep an eye on them, I do – always muckin' about round 'ere."

"That kid of Rotkopf's is out at all hours, y'know – the spotty one. I reckon he's got a sweetheart somewhere. Up all night lookin' at the stars, he was – an' not with a telescope like 'is boss, either."

"Saw that Doctor Markus in the Dragon last night – dear me, the state he was in. Couldn't 'ave stood upright to save 'is life – not even if 'e'd 'ad six pair o' legs! Someone carted 'im back to Koester's in the end – sleepin' like a baby, 'e was – and I'd be very surprised if 'e remembers a thing about it."

Albert Waarmans is a weatherbeaten, wrinkled old man, stooped by age but still mentally active. The job of looking after the warehouse ("the lockup" as he calls it) is not a demanding one, and most of the time he does pretty much what he pleases. He is more fortunate than many Marienburgers of his age without families to support them, since the job gives him free accommodation in the shack next to the warehouse and enough money for food and a few drinks in the Long Dragon (SL18). Albert is a contented individual, and loves nothing more than a few beers and a good gossip. He sees and hears a good deal of what goes on in and around Potion Square, and spends so much time watching his neighbours, in fact, that he is completely unaware of the fact that the lockup is sometimes used by smugglers working in collusion with Dirck Oester (SL20a) next door.

Albert is well-known in the Long Dragon, although he doesn't know all its secrets. His predilection for gossip makes him an unwitting look-out for Grossbart (SL18c) and his minions. He is forever chasing orphans (SL14d) away from the lockup, but he does this more for his own enjoyment than for any fear of theft or damage. He makes regular small donations to the Edelmoed Temple (SL10) – he's fallen on his feet and found a nice little job to keep him going into his old age, and the donations are as much a bribe to keep Shallya sweet as they are alms for the needy. He is also a paid-up member (a penny a week) of Edvard Strattner's (SL33a) shrine club a little further down Dock Road. Albert worked on the docks as a younger man, and his acquaintance with Lea-Jan Cobbius (SR5a) goes back decades. He believes that Cobbius secretly keeps an eye on him, which accounts for the lack of trouble at the warehouse; in fact, Cobbius would just about remember him if the two met, and is much more interested in taking a share of the contraband that passes through there. Albert knows Granny Hetta (SB26a) but the two don't get on – neither wants to stop talking and listen to the other one!



M	WS	BS	S	T	W	I	A	Dex	Ld	Int	Cl	WP	Fel
3	32	26	3	5*	8	20	1	22	35	33	30	28	41

Note that Albert's scores in some characteristics have been reduced to reflect his age.

Age: 68

Alignment: Neutral, particularly respects both Ranald the Protector and Shallya.

Skills: Carpentry; Dodge Blow; Drive Cart; Read/Write; Strike to Stun; Very Resilient*.

Possessions: leather jack and cap (0/1 AP, head/body/arms); dagger (I +10, D -2, P -20); club; lantern; keys; bottle of rum.

ILLICIT DEALINGS

More complete details of Oester's smuggling operation will be found in the description of his shop (SL20). At any time, there is a 20% chance that a quantity of contraband of some kind is being stored in the lockup behind and beneath one of the piles of jerkins and aprons. Oester makes a habit of talking to Albert, so he always knows when the lockup is about to be cleared and he can move his contraband before that happens. If any contraband is found here Albert could be in serious trouble unless someone finds the secret door and can prove the connection with Oester.

LOEWIJER'S TANNERY SL23

Loewijer's is one of the many small tanneries in the leatherworking district of Luydenhoek. It is set a little way behind Tanner's Alley, in the maze of side-streets and alleyways. One end of the building stands on Canal Street, but it is without doors or windows - instead, it has a colourful mural of a stack of leather hides and a sign reading **LOEWIJER'S TANNERY - Entrance at Side**. The sign doesn't say which side the entrance is on, but it doesn't matter since there are doors on both sides of the building.

Beside each door is a pit, 5ft square and 5ft deep and covered over with planks. At least, it's covered over with planks so long as Mats remembers to put them back. Some late-night revellers making their way home from the Long Dragon through these alleys sometimes fall into a pit in the darkness. The pits are used for storing the tanning mixture, an evil-smelling concoction made from the bark of certain trees, sour wine and other, less pleasant substances. It is a 1-yard fall into the pits, and anyone falling in suffers a -20 penalty to Fel tests until they get cleaned up. If they have any unhealed wounds when they fall in, they must make a T test or the wounds become *infected*.

The building itself consists of two large rooms connected by a narrow passage. The front room on the ground floor is used for scraping, trimming and cleaning hides, and the back room - which has a deliver door facing towards Tanner's Alley - contains three tanning pits like those outside, except that they now contain hides in various stages of tanning. A ladder leads up the upper floor from here, as does a ramp from the front room. There is no passage on the upper level - the space is occupied by a rope drying rack for hanging hides when they come out of the pits.

Anton Loewijer (SL23a) Artisan (Tanner), ex-Artisan's Apprentice, ex-Marine, ex-Mercenary Sergeant

"Go outside and look at the sign. Get someone to read it to you if you're not sure. You'll find it says 'Loewijer's Tannery'. Tannery, right? That means we tan hides here, see? What it doesn't say is 'Loewijer's Leather Shop'. And because it doesn't say 'Loewijer's Leather Shop', that means we don't sell leathers. We just tan them. With me so far? Good. So - if you want to buy leather, try going to a leather shop. You'll find quite a few around here. They have signs outside saying 'Leather Shop'."

"NOT THERE! Why is it that people always stand in the way? Go in the front and I'll be with you when these are pegged up."

"Right - what've you got, how many and when for? This job'll last for another week, and it's a regular so I can't hold it up for new trade, but if you can fit around that we're in business."

"MATS! Where are you, you idle... Just look at this! I don't put lids on these outside pits just because I like the look of them, you know! Someone goes walking down the alley, not looking where



they're going, or maybe it's dark and they've had one too many in the Dragon, and down they go. And all because you're too bone idle to put a few planks back where you found them! Right, then - you can spend the morning mucking out Number Two Pit, and when I come back I want to see it so clean you could put a bed in and charge a Guilder a week!"

Anton Loewijer is a stocky, fiery man in his late twenties. His service in the forces of the Onderzoeker merchant family have left him with two missing fingers and an impressive scar on his right arm, and a brusque manner with no time for idiots. He dresses in stout breeches and heavy boots, with a heavily-stained leather apron over the top. He only wears a shirt indoors in the coldest of weather.

Anton served as a marine for several years, rising to the rank of sergeant before he retired. His father had been a tanner, so Anton took to the trade and applied the brusque efficiency he developed during his military career. Although his workload is increasing steadily as his reputation spreads, he still manages to keep the tannery running smoothly with just two apprentices.

Occasionally, Anton will receive a batch of rare or exotic hides - he's had practical experience of tanning Wyvern hide, for instance - and then he will visit Wilhelm Rotkopf (SL12a) for any special ingredients. Lisette (SL13a) sometimes buys hides from him, and while the two are not close friends they do seem to have a certain rapport based on their directness. Like Lisette, he is a member of the Leatherworkers' Guild (SL42). Sister Marianne (SL14a) talked Anton into taking Mats (SL23a) as an apprentice, and he hasn't quite forgiven her. While not uncharitable,

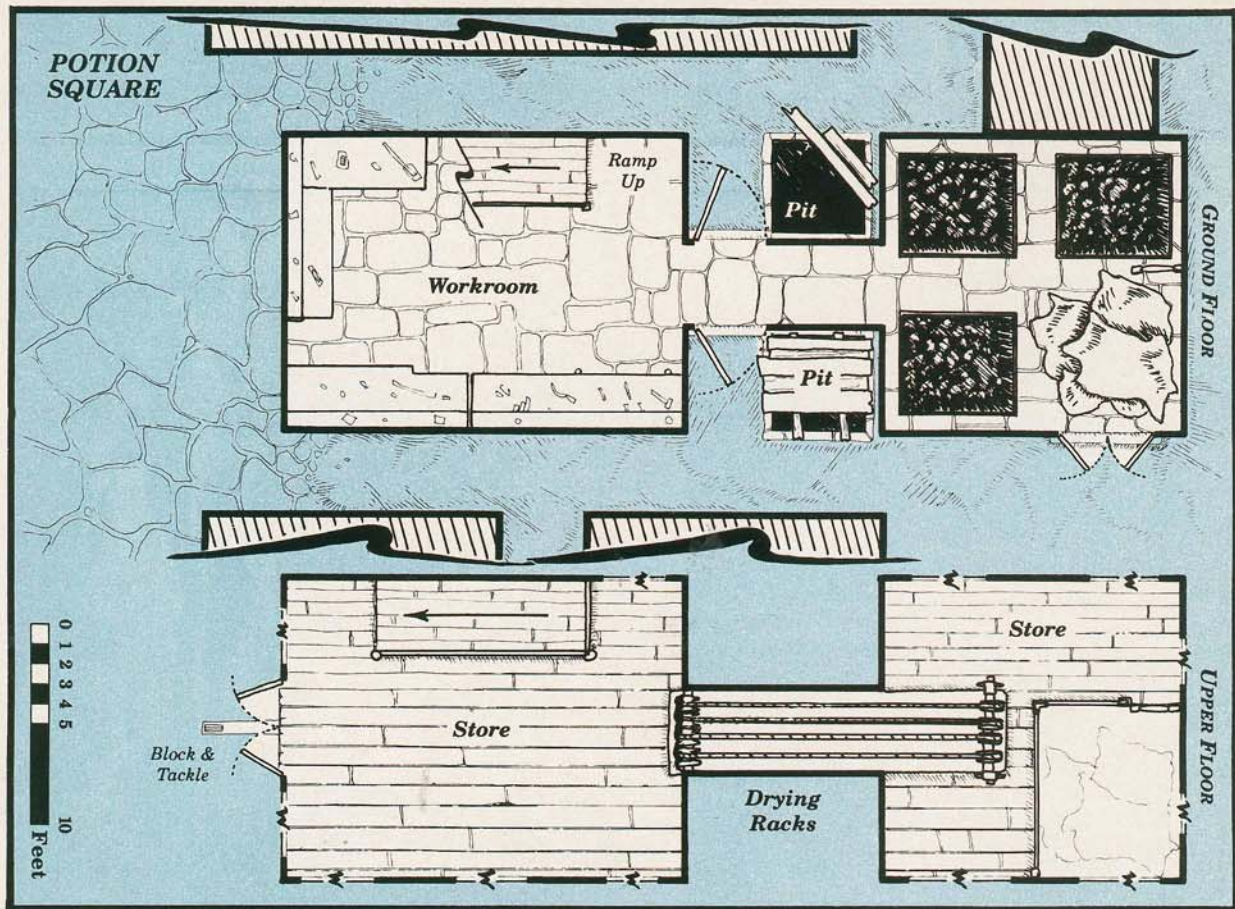

Anton believes has no time for scroungers. Brother Marijkus (SL10a) has long since given up asking his surly neighbour for contributions. Anton's time is occupied by his business, and he doesn't frequent any of the local hostleries, but he does occasionally buy exotic spirits from Ishmael (SB12a) at the Pelican's Perch – he is fond of Lustrian mezcal, which reminds him of his travelling days. Anton is a member of the Reserve Militia attached to the House of Onderzoeker (C31).

M WS BS S T W I A Dex Ld Int Cl WP Fel
4 53 41 4 5* 11 48 2 39 45 41 43 37 35

Age: 27

Alignment: Neutral (Manann)

Skills: Brewing; Chemistry; Consume Alcohol; Disarm; Dodge Blow; Drive Cart; Read/Write; Row; Secret Language – Battle Tongue, Guildler; Secret Signs – Artisan (Leatherworker's Guild); Street Fighter; Strike Mighty Blow; Strike to Stun; Swim; Very Resilient*.

Possessions: Leather apron (0/1 AP, body/legs); dagger (I +10, D -2, P -20); sword, sleeveless mail shirt and shield kept in trunk under stairs.

Mats Vaadsig (SL23b), Artisan's Apprentice

- About 11, scruffy, tousled straw-coloured hair.
- Lazy, inattentive, clumsy.

- Avoid work and Anton's wrath, both together if possible.
- "Err... dunno."
- Knows most of the orphans (SL14d etc), hangs around the Long Dragon (SL18).

M WS BS S T W I A Dex Ld Int Cl WP Fel
4 31 36 2 3 6 26 1 39 26 29 24 31 27

Skills: Concealment Urban; Dodge Blow; Drive Cart; Flee!

Possessions: nothing of note.

Maxentius 'Maxie' Appledown (SL23c), Artisan's Apprentice

- Young, slim (for a Halfling!), curly red-brown hair.
- Brisk, friendly but slightly reserved, lacks confidence.
- Learn tanning, set up in own business.
- "No problem."
- Runs errands to Rotkopf (SL12a) and van Arzneier (SL9a). Extensive family in Halfling Row (C60). Hopes to marry Janna Mossfoot (SL12f).

M WS BS S T W I A Dex Ld Int Cl WP Fel
3 25 33 2 3 5 53 1 55 24 35 26 42 47

Skills: Brewing; Cook; Herb Lore; Drive Cart; Read/Write.

Possessions: dagger (I +10, D -2, P -20); notebook and charcoal stick. ■

GAMES WORKSHOP™

CAREER OPPORTUNITIES

Games Workshop currently has a number of vacancies at its busy Design Studio in the centre of Nottingham. This is where White Dwarf and all our games are designed, written, edited, illustrated and prepared for printing.

We are looking for committed and enthusiastic individuals who are already immersed in the world of hobby gaming and who are intimately familiar with our Warhammer games and the associated ranges of Citadel Miniatures.

The successful applicants will find themselves in a hard-working team, dedicated to the creation and production of the finest hobby games material in the world.

PROJECT MANAGER'S ASSISTANT

This busy department at the Design Studio handles areas such as marketing, advertising, publicity and new projects development. Activities range from joint projects with television companies, overseas licensing, White Dwarf advertising, and exploring new areas of interest (such as records) through to administrative tasks such as ensuring that the vast range of Games Workshop products meet current UK and European toy safety standards.

First and foremost, you need to be very enthusiastic about everything to do with Games Workshop. You need a good telephone manner and the ability to think on your feet – you'll need to be able to explain who we are and what we do in a concise, practical fashion in terms which an outsider is likely to understand.

You must be mature, professional, level-headed and highly-motivated. You'll be expected to work on projects at every stage from initial ideas through to the final production of boxes, album covers etc – whatever's needed to see the project through. You need to be able to work both on your own and under close supervision as part of a creative team. You must also be able to set up and monitor administrative systems for maintaining records, tracking adverts and so forth. You should expect to work late to meet tight deadlines.

In short, you've got to be flexible, intelligent, reliable and able to work under pressure. Write enclosing a full cv to Andy Jones at the address below.

ART EDITOR

The job of art editor involves scheduling and monitoring the work of in-house and freelance artists, assessing the illustrations required for every project and ensuring that the illustrations contribute to the evocation of our gaming milieus – we don't just want words translated into pictures, we want illustrations that complement the words and add to our game worlds in their own right.

You'll be writing briefs, collating reference material, maintaining a close and regular contact with the artists, supervising our cross-indexed art-filing system, keeping records of all commissions, and administering payments.

You need to demonstrate an appreciation of illustration and be able to understand the problems of communicating with artists in order to get the best out of them. You must also be familiar with the world of hobby gaming, have a love of miniatures and an enthusiasm for Warhammer in all its guises.

You must be a mature, responsible individual capable of working well as part of a team. Experience in a related field would be an advantage.

Write enclosing a full cv to Phil Gallagher at the address below.



STAFF WRITER

We're looking for a mature, experienced writer with considerable command of a variety of tones and styles who can evoke the reality of our gaming milieus.

It's not absolutely essential to have had anything published, but if you've never even sent a piece of work to a publisher, you're unlikely to have the skills we need.

You need to be able to produce evocative narrative and dialogue at the drop of a hat. You must be willing and able to write to briefs which will vary from the extremely vague to the rigidly tight, to produce work which can both complement pre-existing illustrations, background essays and rules material, and develop the overall setting.

You must have experience of hobby gaming and, ideally, will be a Warhammer player. You must be prepared to become intimately familiar with our game worlds, both in tone and content.

Experience of word processing and/or DTP would be an advantage.

Write, enclosing a full cv and sample written material, published or not, to Simon Forrest at the address below.

GAMES WORKSHOP DESIGN STUDIO, ENFIELD CHAMBERS, 14-16 LOW PAVEMENT, NOTTINGHAM NG1 7DL

GAMES WORKSHOP™ MAIL ORDER

PRICE LIST

CODE	DESCRIPTION	UK PRICE	CODE	DESCRIPTION	UK PRICE
071533	ELDAR JET CYCLES		070703	SQUIG KATAPULT	
	ELDAR JET CYCLE & RIDER	£3.99		(INCLUDING RUNTHERD AND 3 RUNTZ)	£6.99
	RIDER TORSO	£0.50		RUNTHERD	£1.00
	LEGS	£0.50		KATAPULT FRONT	£1.50
	CANOPY	£1.00		KATAPULT BASE	£1.50
	SADDLE	£1.00		RUNT WITH BUZZER SQUIG POT	£0.75
	HANDLEBARS	£0.50		RUNT WITH DAGGER	£0.75
ARMAMENT	£1.00	RUNT WITH BAG OF SQUIGS		£0.75	
		PILE OF SQUIGS		£0.50	
		WINDING HANDLE		£0.50	
		KATAPULT ARM		£0.50	
		WHEEL	£0.75		
072072	IMPERIAL GUARD ON BIKES		070683	ORK FREEBOOTERZ	
072060	COMPLETE JET BIKE & RIDER	£3.99		FLASH GIT NOB WITH POWER CLAW AND KUSTOM WEAPON	£2.50
	COMPLETE BIKE & RIDER	£3.99	ANY OTHER FREEBOOTERZ	ANY 2 FOR £3.99	
	RIDER TORSO	£0.50			
	RIDERS LEGS	£0.50			
	JET BIKE FAIRING	£1.50			
	JET ENGINE	£1.00			
	STABILIZER FINS	£0.50			
	BIKE FAIRING	£0.50			
	BIKE	£2.75			
	STORM WARRIORS	£4.99			
	COMEBACK TOUR	£4.99			
	'ERE WE GO	PHONE FOR DETAILS			
	CHAOS SPACE MARINES	ANY 2 FOR £3.99			
			071572	ELDAR ASPECT WARRIORS	
				ASPECT WARRIOR EXARCHS	£2.00 EACH
			071560	ASPECT WARRIORS	
				(INCLUDING WINGS & MISSILE LAUNCHERS)	ANY 4 FOR £3.99
				HAWK WINGS	£0.50
				EXARCH HAWK WINGS	£1.00
				MISSILE LAUNCHER	£0.50

The new increased prices shown above come into effect from 18th March. For details of new US prices phone US Mail Order.

ORDER FORM

CODE / DESCRIPTION	QTY	TOTAL PRICE
TOTAL:	POSTAGE & PACKING:	GRAND TOTAL (TOTAL + P&P) =
NAME AND ADDRESS:		
.....		

HOW TO ORDER CITADEL MINIATURES

We strongly recommend that you 'phone in your orders. You'll be talking directly to the Mail Order specialist who'll actually be packing and dispatching your order. He'll be able to tell you exactly what is and isn't available, and suggest alternatives in the case of any problems. He will also be able to tell you about any new models that have become available since last issue, and any special offers we may be running on old, discontinued or overstocked items.

If it's simply not possible for you to order by phone then it doesn't matter too much. All you have to do is tell us the name (if available) and code. Be as explicit as you can when writing out your descriptions of the models you want. This is particularly important if you want to order a particular combination of parts for a multi-part kit. We recommend using block capitals to avoid confusion!

ALTERNATIVES

You should always let us have a list of alternatives when ordering by post. Even if you make an order by 'phone, it is wise to give a few alternatives. The only reason we won't be able to supply you with a model is if it has been discontinued and the mould is no longer available on the factory floor. Normally speaking we manage to supply 95% of all orders. Our staff will be happy to suggest viable alternatives for any models which are out-of-stock or no longer produced.

DESPATCH AND DELIVERY

We always try to despatch your orders within 2 days of receipt; quite often we get them out the same day. Remember that parcels take longer than letters, but you should, in general, get your order back within 10 days. We do occasionally get behind, but this usually only happens when we hold a large sale with lots of irresistible offers, and at Christmas.

FOREIGN ORDERS

We are very happy indeed to supply foreign orders through our UK Mail Order Department.

POSTAGE & PACKING

Total up your order and add the following postage & packaging costs:

UK & BFPO: add £2.50

Overseas (including Eire): add 40%. If you pay by credit card, P&P will be charged at cost.

METHODS OF PAYMENT

You can pay by cheque or postal order. Alternatively, we take Access and Visa cards - write with your order, and include the card number, the cardholder's name and signature, the card expiry date, and your name and address. Better still, phone our Mail Order Hotlines to place an immediate order - make sure you have your Access or Visa card with you when you phone.

UK MAIL ORDER

Our UK Mail Order Hotlines are open for your orders from 8.30am to 6.30pm on weekdays. The numbers to ring are (0773) 760462 or (0773) 713213

If you're writing in with your order, send it to:

GAMES WORKSHOP MAIL ORDER SERVICE,
CHEWTON STREET, HILLTOP,
EASTWOOD,
NOTTINGHAM NG16 3HY

Or you can fax the order through on (0773) 530155

US MAIL ORDER

For US telephone orders (Visa and Mastercard only) ring (301) 644 5699, Monday through Friday between 9.00am and 5.00pm EST. Or you can post orders to:

GAMES WORKSHOP MAIL ORDER SERVICE,
3431 BENSON AVENUE,
BALTIMORE, MARYLAND 21227



Please add \$3.00 postage and handling. Maryland residents add 5% sales tax, residents in Virginia add 4.5% sales tax, residents in California add 6.75% sales tax and residents in Pennsylvania add 6% sales tax. Write for free catalogue.

Cash, COD, and Canadian Postal Money orders are not accepted. Minimum order is \$20.00 and postage will be free if your order is over \$120.00.

You can also fax Access and Visa miniatures orders direct to the US on (301) 242-1839. Please remember to include the card number, the cardholder's name and signature, the card expiry date and your name and address. Handling will be charged at 40% or cost, whichever is cheaper.

CANADIAN MAIL ORDER

For Canadian telephone credit card orders (Visa and Mastercard only), ring (416) 595 1159, Monday to Saturday between 11.00am and 8.00 pm EST.

Postage and handling will be charged at cost. Please note that we are taking telephone credit card orders only. For postal orders, please contact our US Mail Order Service.

ORK FREEBOOTERZ



FLASH GIT NOB WITH POWER CLAW AND KUSTOM WEAPON



RENEGADE MEK WITH BIONIK WEAPON
070683/6



BAD DOC WITH BIONIK POWER CLAW
070683/7



FREEBOOTER BOY 1
070683/3



FREEBOOTER BOY 2
070683/5



FREEBOOTER KAPTIN
070683/4



STORMBOY OF KHORNE
070683/1



PIRATE WITH BIONIK BODY
070683/2



FLASH GIT NOB
070683/14



FREEBOOTER BOY 3
070683/13



ORK/GENESTEALER HYBRID
070683/12



ORK CHAOS CHAMPION
070683/8



FREEBOOTER BOY 4
070683/9



ORK MUTANT
070683/10



FREEBOOTER BOY 5
070683/11



WARHEAD WEIRDBOY
070683/15

ALL THE ORKS ABOVE ARE SUPPLIED COMPLETE WITH PLASTIC ARMS AND WEAPONS WHERE APPROPRIATE. THE MINIATURES BELOW ARE EXAMPLES OF JUST SOME OF THE COMBINATIONS YOU CAN CREATE.

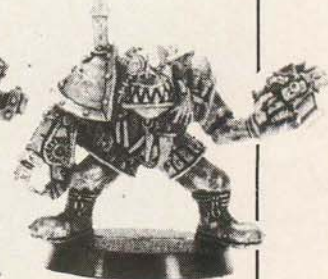

ASPECT WARRIORS

Designed by Jes Goodwin



**HOWLING BANSHEE EXARCH
WITH POWER AXE AND LAS PISTOL**
071572/3



**HOWLING BANSHEE WITH
POWER SWORD AND LASPISTOL 1**
071560/1



**HOWLING BANSHEE WITH
POWER SWORD AND LASPISTOL 2**
071560/9



**HOWLING BANSHEE WITH
POWER SWORD AND LASPISTOL 3**
071560/15



**DIRE AVENGER EXARCH
WITH POWER SWORD**
071572/7

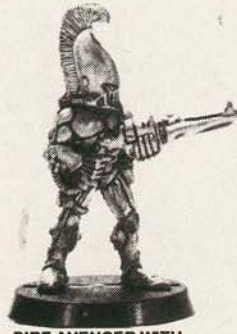

**DIRE AVENGER WITH
SHURIKEN CATAPULT 1**
071560/5



**DIRE AVENGER WITH
SHURIKEN CATAPULT 2**
071560/12



**DIRE AVENGER WITH
SHURIKEN CATAPULT 3**
071560/18



**STRIKING SCORPION EXARCH
WITH BITING SWORD AND
SHURIKEN PISTOL**
071572/4



**STRIKING SCORPION
WITH CHAINWORD AND
SHURIKEN PISTOL 1**
071560/2



**STRIKING SCORPION
WITH CHAINWORD AND
SHURIKEN PISTOL 2**
071560/10



**STRIKING SCORPION
WITH CHAINWORD AND
SHURIKEN PISTOL 3**
071560/16

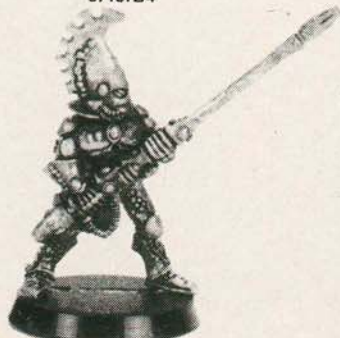

**FIRE DRAGON EXARCH
WITH FIREPIKE**
071572/8



**FIRE DRAGON WITH
MELTAGUN 1**
071560/6



**FIRE DRAGON WITH
MELTAGUN 2**
071560/13



**FIRE DRAGON WITH
MELTAGUN 3**
071560/19

Minatures supplied unpainted. WARNING! This product contains lead which may be harmful if chewed or swallowed. Citadel Miniatures are not recommended for children under 14 years of age.



ASPECT WARRIORS

Designed by Jes Goodwin



**SWOOPING HAWK EXARCH
WITH LASBLASTER**
071572/5
(AND EXARCH HAWK WINGS)



**SWOOPING HAWK
WITH LASGUN 1**
071560/3
(AND HAWK WINGS)



**SWOOPING HAWK
WITH LASGUN 2**
071560/11
(AND HAWK WINGS)



**SWOOPING HAWK
WITH LASGUN 3**
071560/17
(AND HAWK WINGS)

TO COMPLETE YOUR SWOOPING HAWK AND SWOOPING HAWK EXARCH MODELS YOU WILL NEED EITHER OF THE SEPARATE HAWK WINGS OR EXARCH HAWK WINGS



HAWK WINGS
071560/4



**EXARCH HAWK
WINGS**
071572/6



EXARCH - FIRE DRAGONS



EXARCH - SWOOPING HAWK

TO COMPLETE EITHER OF THE DARK REAPER MODELS 1 AND 2, YOU WILL NEED THE SEPARATE MISSILE LAUNCHER



**DARK REAPER EXARCH
WITH WEB OF SKULLS AND
SHURIKEN PISTOL**
071572/9

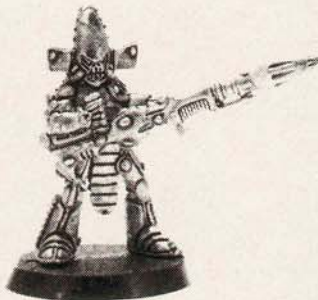

DARK REAPER 1
071560/7
(AND MISSILE
LAUNCHER)



DARK REAPER 2
071560/14
(AND MISSILE
LAUNCHER)

MISSILE LAUNCHER
071560/8

Miniatures supplied unpainted. WARNING! This product contains lead which may be harmful if chewed or swallowed. Citadel Miniatures are not recommended for children under 14 years of age



**CITADEL™
MINIATURES**

ELDAR JET CYCLES

DESIGNED BY JES GOODWIN

EXAMPLES OF THE ASSEMBLED
JET CYCLES

RULES FOR ELDAR
JET BIKES ARE IN
THIS WHITE DWARF



ELDAR JET CYCLE RIDER WITH
SHURIKEN PISTOL
071533/7



HARLEQUIN JET CYCLE RIDER
WITH POWER SWORD
071533/11



ELDAR RIDERS
LEGS
071533/5



ELDAR JET CYCLE
RIDER
071533/6



HARLEQUIN RIDERS
LEGS
071533/10



HARLEQUIN JET CYCLE
CANOPY
071533/8



ELDAR JET CYCLE
CANOPY
071533/1



JET CYCLE
SADDLE
071533/3



JET CYCLE
HANDLE BARS
071533/4

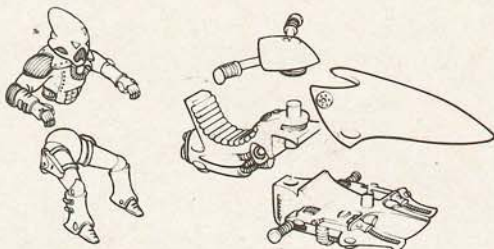

THIS MODEL WILL REQUIRE ASSEMBLY
AS SHOWN IN THE EXAMPLE ABOVE
WE HAVE MADE THE PIECES INTERCHANGEABLE
SO YOU CAN HAVE THE CHOICE OF CANOPY,
RIDER AND ARMAMENT.



SHURIKEN CANNON
ARMAMENT
071533/9



DUEL SHURIKEN
CATAPULT ARMAMENT
071533/5



CITADEL
MINIATURES

IMPERIAL GUARD ON BIKES

RULES FOR THE IMPERIAL
JET BIKE ARE IN THIS
WHITE DWARF

THREE EXAMPLES OF COMPLETED
JET BIKES WITH IMPERIAL GUARD
RIDERS



JET BIKE FAIRING WITH
TWIN BOLTER MOUNTS
072072/1



JET ENGINE
072072/2



STABILIZER FINS
072072/3

THE JET BIKE IS SUPPLIED
WITH A FLYING STAND

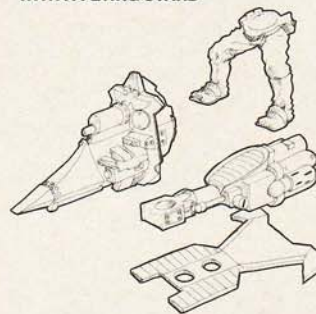

ALL THE MODELS EXCEPT THE GUARD
WITH THE GRENADE LAUNCHER ARE
SUPPLIED WITH PLASTIC ARMS AND
WEAPONS



LIEUTENANT'S
TORSO WITH
CHAINSWORD
072072/11



GUARD TORSO
WITH GRENADE
LAUNCHER
072072/7



COMMISSARS
TORSO WITH
POWER SWORD
072072/5

THE MODEL WILL REQUIRE ASSEMBLY
AS SHOWN IN THE EXAMPLE ABOVE
THE PIECES ARE INTERCHANGEABLE
SO YOU CAN HAVE THE CHOICE OF
RIDER



CAPTAINS
TORSO
072072/13



LIEUTENANTS
TORSO
072072/12



COMMISSAR
TORSO
072072/6



MEDIC TORSO
072072/15



STANDARD BEARER
TORSO
072072/8

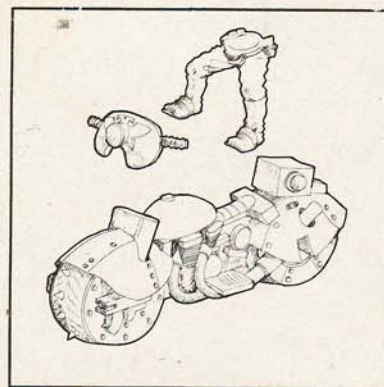

THE MODEL WILL REQUIRE ASSEMBLY
AS SHOWN IN THE EXAMPLE ABOVE
THE PIECES ARE INTERCHANGEABLE
SO YOU CAN HAVE THE CHOICE OF
RIDER AND FAIRING



GUARD TORSO 1
072072/9



GUARD TORSO 2
072072/10



COMMANDERS
TORSO
072072/14



RIDERS LEGS
72072/4



BIKE FAIRING 1
072060/2



BIKE FAIRING 2
072060/2



BIKE WITH TWIN
BOLTER MOUNTS
072060/1

THREE EXAMPLES OF COMPLETED
BIKES WITH IMPERIAL GUARD
RIDERS



Miniatures supplied unpainted. WARNING! This product contains lead which may be harmful if chewed or swallowed. Citadel Miniatures are not recommended for children under 14 years of age.



CHAOS SPACE MARINES

ALL MODELS SUPPLIED WITH CHAOS BACKPACK

Designed by Jes Goodwin



WORLD EATER
SPACE MARINE OF KHORNE
WITH CHAINWORD AND BOLTGUN



DEATH GUARD
SPACE MARINE OF NURGLE
WITH BOLTGUN



EMPEROR'S CHILDREN
SPACE MARINE OF SLAANESH
WITH BOLTGUN



THOUSAND SONS
SPACE MARINE OF TZEENTCH
WITH BOLTGUN

SQUIG KATAPULT

Designed by Kev Adams



RUNTHERD WITH WHIP
(SUPPLIED WITH PLASTIC ARM)
070703/6



RUNT WITH BUZZER
SQUIG POT
070703/8

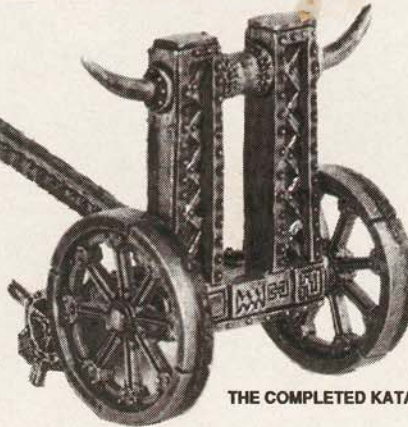

THE COMPLETED KATAPULT



RUNT WITH
DAGGER
070703/9



RUNT WITH A
BAG OF SQUIGS
070703/7

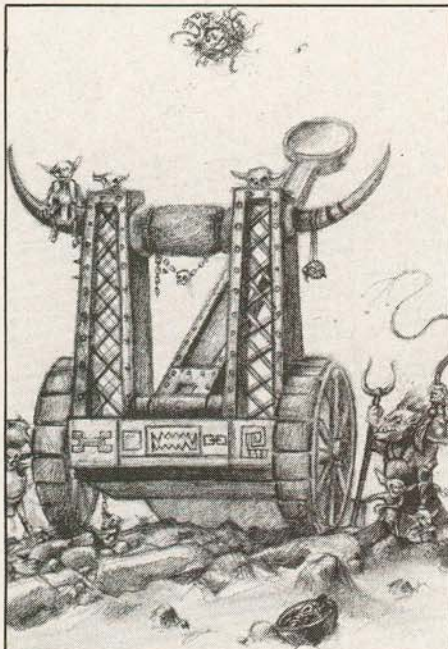

THE RULES FOR THE SQUIG KATAPULT ARE IN 'ERE WE GO

THE SQUIG KATAPULT COMPRISES THESE PARTS
AND THE RUNTHERD AND THREE RUNTS SHOWN ABOVE



WINDING
HANDLE
070703/4



PILE OF
SQUIGS
070703/5

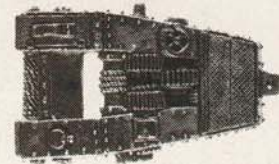

KATAPULT
BASE
070703/2



KATAPULT
ARM
070703/3



WHEEL
070703/10

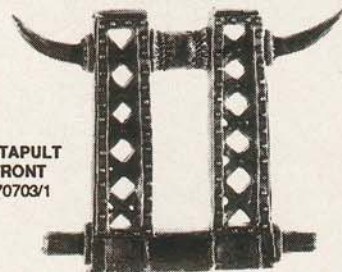

KATAPULT
FRONT
070703/1



CITADEL
MINIATURES

FLAME WARHAMMER FANTASY ROLE PLAY

Warhammer Fantasy Roleplay is a roleplay adventure game in the unique fantasy setting of the Old World. The Old World stretches from the twisted northern Chaos Wastes to the pirate coast of south Tilea; from the Elf-haunted Laurelorrn Forest to the cities of The Empire; lands packed with intrigue, danger and adventure. You play a wizard, pit fighter, mercenary, outlaw – any of over 100 character types – skilled in the arts of battle and sorcery, an adventurer in the perilous and Chaos-infested Warhammer world, opposed by Orcs, Goblins, Skaven, Undead creatures of the night and dozens of other monstrous enemies (all available as Citadel Miniatures). Warhammer Fantasy Roleplay provides an unmatched depth of background and atmosphere, with a fast, detailed and flexible game system, exciting combat and powerful magic.

FLAME publish an ever-growing range of adventure books, rules expansions and source packs for Warhammer Fantasy Roleplay. From exploration in the underground depths of ruined Dwarf halls to battles against armies of Skeletons; from intrigue in the twisting streets of Marienburg to dark sorcery in mountain fortresses; from advanced game rules to new spells and magical artefacts.

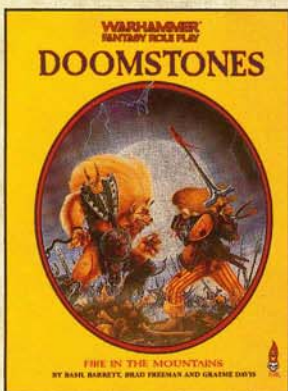

FIRE IN THE MOUNTAINS

The Yetzin Valley stands at the southern end of a vital pass over the Vaults Mountains. A hundred years ago, the valley was conquered by the Orcs of the Bloodaxe Alliance – theirs, however, was a brief and bloody reign, and is now all but forgotten. A chance discovery in the mountains puts the adventurers on the trail of the Alliance, retracing the last journey of the warrior-priest Torgoch. His path leads the adventurers towards the fabled Crystal of Fire. £7.99

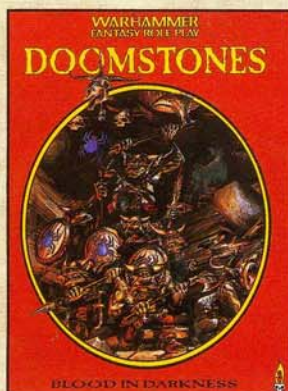

BLOOD IN DARKNESS

The century-old path of a renegade Orc warchief leads through the foothills of the Vaults Mountains to the relics of a mutiny, an ancient Dwarven shrine and a second Crystal of Power. Finding the shrine is just the beginning – beyond lie age-old Dwarven defences and the tunnels' current dwellers. Blood in Darkness mixes investigation and combat to present Warhammer Fantasy Roleplay adventurers with a constant challenge. £6.99

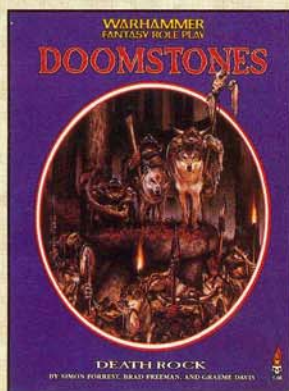

DEATH ROCK

The Orcs of the Bloodaxe Alliance once again threaten the Yetzin Valley. Their target is the great monastery of Eyrie, standing high on a pinnacle of rock above the Winter's Teeth Pass. A century ago it was to Eyrie that the Dwarf-mage Yazeran fled with the fabled Crystal of Air. Now the adventurers must reach the monastery and find the Crystal before the Orc army, driven on by its sorcerous master, attack. And to succeed, they must first solve the puzzle that Yazeran left behind. £6.99

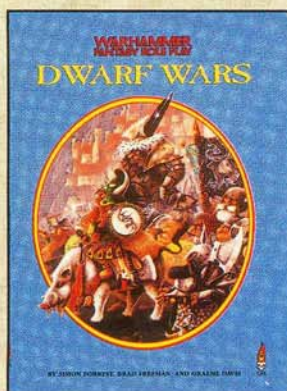

DWARF WARS

A lost Dwarfhold has been found: Kadar-Graving, Hold of legendary Hargrim, a Dwarf-King without equal. To the Dwarfs, there is no greater symbol of rulership than Hargrim's Crown. But finding the crown won't be easy. Large parts of the Hold are in ruins and the Royal Tombs are ringed by deadly traps. Whoever reaches the Hold first can be sure the enemy is not far behind. £7.99



CHARACTER PACK

This pack contains 50 character sheets for Warhammer Fantasy Roleplay plus a 16-page booklet detailing the Graf Manfred – a large city inn. The Graf Manfred is an ideal adventure location or base for adventurers, and its staff and regulars are presented as 22 fully-detailed and ready-to-use NPCs. The pack also includes adventure outlines to get your started. £4.99

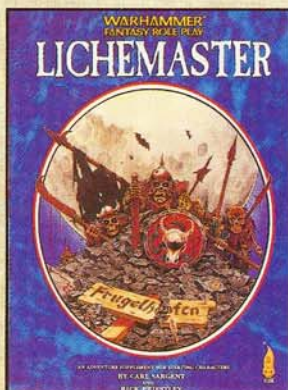

LICHEMASTER

Fifteen years have passed since the necromancer Heinrich Kemmler was trapped and defeated. But his evil is about to begin anew. High in the Grey Mountains, an Undead Army masses among the peaks. In an isolated monastery, one monk suspects the truth. But where will the Undead strike? And how can they be stopped? £7.99

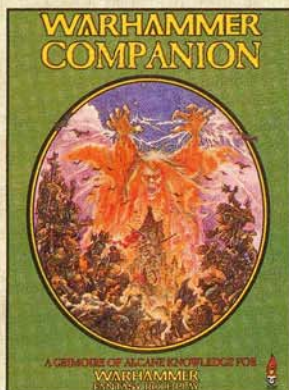

WARHAMMER COMPANION

A rare mixture of diverse materials for GMs and players of Warhammer Fantasy Roleplay. Within these covers you'll find four complete adventures, a wide range of articles presenting new character careers, spells, magical items and advanced rules, plus a special selection devoted to Jack Yeovil's Warhammer novel, Drachenfels.



IN THE WORKS

As well as the books we've already published, we're working on a range of new Warhammer Fantasy Roleplay supplements and adventures. We'll be announcing these in White Dwarf as soon as they're available, but for now here's an outline of some of our ideas.

We're working on a village pack set in the lands where the Empire, Tilea and the Border Princes join. Going under the working title of *Death's Dark Shadow*, this will probably contain new rules, adventure outlines and several fully-detailed adventures. The villages of the Old World are not always what they seem and who knows what dark secrets the players may uncover?

Sometime in the future, we're also hoping to do a book based on Jack Yeovil's Warhammer novel, *Drachenfels*, with the castle of the Great Enchanter as a location for Warhammer Fantasy Roleplay adventures. This should include large-scale maps of the castle, with rules for the castle's own magical abilities and plenty of castle-based encounters. For the bravest of adventurers, there may even be a chance to battle against Drachenfels himself.

Over recent months, adventure locations from the city-port of Marienburg have been appearing in White Dwarf. As well as the published material, we're building up a large stock of unpublished locations, including details of many places that have only been referred to in White Dwarf. These include locations and NPCs such as graveyards, criminal gangs, the Thieves' Guild, pit fighters, docks, boatyards... Eventually, we'll gather this material together into a city adventure pack.

Also in the pipeline but nowhere near release are a book on Lustria and a magic supplement. Lustria is a strange new land of adventure across the sea where the alien technologies of the Slann lie ruined in the jungle. The planned magic book will be a major supplement that vastly expands the Warhammer Fantasy Roleplay magic system with complete details of many different types of wizard and a huge range of new spells.

WHITE DWARF

We also produce regular Warhammer Fantasy Roleplay articles for White Dwarf and there's plenty more planned for future issues. Keep an eye on the magazine for details of future releases.

MAIL ORDER

Flame products are available from Games Workshop stores and by Mail Order direct from us. Make cheques payable to Flame Publications. Please make all payments in pounds sterling. Handling charges on UK, Eire and BFPO orders: add £2.50 for all orders. Overseas airmail: minimum order £5.00, add 40% for handling (minimum handling £2.50).

Telephone credit card orders (Visa, Access or Mastercharge) direct to us on 0602 500459, Monday-Friday 10am-5pm. Or send an SSAE to the address below for Mail Order details.

In the USA contact Games Workshop US Mail Order Service (301 644 5699).





Paul Banner